

AM/FM STEREO RECEIVER

SX - 626

KCU

<ART-155-0>



 **PIONEER®**

SERVICE MANUAL

AM / FM STEREO RECEIVER

SX-626

KCW, KUW, FVZW, NBW, FW

NOTE:

MODEL SX-626 COMES IN FIVE VERSIONS DISTINGUISHED AS FOLLOWS:

Round label on rear panel	Voltage	Type
KCW KUW FVZW NBW	120V only 120V only 5-position selector 220V only	CSA approved (Canada) UL approved (U.S.A.) FTZ approved (West Germany) SEMCO (Sweden), NEMCO (Norway) and DEMCO (Denmark) approved
FW	5-position selector	General export model with de-emphasis selector switch

 **PIONEER®**

CONTENTS

1.	SPECIFICATIONS	3
2.	FRONT PANEL FACILITIES	5
3.	CONNECTION DIAGRAM	7
4.	BLOCK DIAGRAM	9
5.	DISASSEMBLY	11
6.	PARTS AND P.C. BOARD LOCATION	
6.1	Top View	12
6.2	Bottom View	13
7.	ALIGNMENT PROCEDURE	
7.1	Required measuring instruments	14
7.2	AM adjustment	14
7.3	FM adjustment	14
8.	DIAL CORD STRINGING	15
9.	PACKING METHOD AND PART NUMBERS	16
10.	EXPLODED VIEW AND PARTS LIST	16
11.	SCHEMATIC DIAGRAMS, P.C. BOARD PATTERNS AND PARTS LIST	
11.1	Circuit Connection Diagram and Miscellaneous Parts	21
11.2	Tuner Assembly (AWE-031)	26
11.3	Equalizer Amplifier Assembly (W21-004)	32
11.4	Control Amplifier Assembly (AWG-008)	35
11.5	Power Amplifier Assembly (AWH-002) (AWH-013)	38
11.6	Power Supply Circuit Assembly (AWR-029)	42
11.7	Switch Circuit Assembly (AWS-013)	44
11.8	Switch Circuit Assembly (AWS-014)	45
11.9	CR & Meter Drive Assembly (AWM-050)	46

NOTE:

This SX-626 Service Manual applies to:

- 1) All the models with IC-indicated round label each attached above the power cords on the rear panels (see page 8); and
- 2) The following five models at which the respective sequence numbers begin:

KUW model	No. 3744801
KCW model	No. 3504201
FVZW model	No. 1612501
NBW model	No. 4301401
FW model	No. 1212001



1. SPECIFICATIONS FACILITIES

SEMICONDUCTORS

FETs	3
ICs	4
Transistors	27
Diodes	12

POWER AMPLIFIER SECTION

Music Power Output (IHF)	110Watts (4 Ω) 76Watts (8 Ω)
Continuous Power Output (each channel driven)	40W/40W (4 Ω) 32W/32W (8 Ω)
Continuous Power Output (both channels driven)	30W + 30W (4 Ω) 27W + 27W (8 Ω)
Power Output in the range of 20Hz to 20kHz (both channels driven)	20W + 20W (8 Ω , Harmonic distortion less than 1%)
Harmonic Distortion	Less than 1% (Continuous power output) Less than 0.09% (16W/16W, 8 Ω output)
Intermodulation Distortion	Less than 1% (Continuous power output) Less than 0.4% (16W/16W, 8 Ω output)
Power Bandwidth (IHF)	10Hz to 70kHz (8 Ω , Harmonic distortion less than 1%)
Frequency Response	5Hz to 80kHz, \pm 1dB
Input Sensitivity/Impedance (1kHz, Continuous power output)	500mV/60k Ω (MAIN IN)
Speakers	4 to 16 Ω
Damping Factor	40 (8 Ω , 1kHz)

PREAMPLIFIER SECTION

Output Voltage	500mV (Rated output), 3V (Max.)
Harmonic Distortion	Less than 0.5%
Frequency Response	15Hz to 20kHz, \pm 1 dB
Input Sensitivity/Impedance (1kHz, for rated output)	PHONO 1 2.5mV/45k Ω PHONO 2 2.5mV/45k Ω MIC 2.2mV/22k Ω AUX 200mV/100k Ω TAPE MONITOR 1, 2 200mV/70k Ω
Recording Output	TAPE REC 1, 2 (Pin jack) 200mV TAPE REC (DIN connector) 35mV
BASS Control	-11 dB, +11 dB/100Hz
TREBLE Control	-11 dB, +10.5 dB/10kHz
LOW Filter	-8dB/50Hz (6dB/oct.)
HIGH Filter	-9dB/10kHz (6dB/oct.)
Equalization Curve	PHONO: RIAA S.T.D.
Loudness Contour	+10dB/100Hz, +6dB/10kHz with Volume Control set at -40dB position.
Hum and Noise (IHF)	PHONO More than 85dB AUX More than 95dB

S. FRONT PANEL FACILITIES

AM TUNER SECTION

Frequency Range	88MHz to 108MHz 87.5MHz to 108MHz (FTZ approved)
Usable Sensitivity (IHF)	2.0 μ V
Capture Ratio (IHF)	2.5dB
Selectivity (IHF)	More than 70dB
Image Rejection	More than 80dB (98MHz)
IF Rejection	More than 100dB (90MHz)
Spurious Rejection	More than 90dB (98MHz)
AM Suppression	50dB
Signal-to-Noise Ratio	70dB
Harmonic Distortion	Mono: Less than 0.4% (100% Mod.) Stereo: Less than 0.5% (100% Mod.)
Tuning Indicator	Signal strength type
Muting	Switchable to ON-OFF
Stereo Separation	More than 40dB (1kHz)
Sub Carrier Suppression	More than 50dB
De-emphasis Switch	50 μ sec., 75 μ sec. (FW model only)
Antenna Input	Impedance 300 Ω balanced and 75 Ω unbalanced.

FM TUNER SECTION

Frequency Range	525kHz to 1,605kHz
Usable Sensitivity (IHF)	10 μ V
Selectivity (IHF)	More than 30dB
Image Rejection	More than 80dB (1,000kHz)
IF Rejection	More than 70dB
Signal-to-Noise Ratio	More than 50dB
Antenna	Built-in, Ferrite Loopstick Antenna

MISCELLANEOUS

Power Requirements	120V 60Hz or 110V, 120V, 130V, 220V and 240V. (Switchable) 50 - 60Hz
Power Consumption	170W (Max.)
Dimensions (overall)	17-11/16in./450mm (width) 5-11/16in./145mm (height) 14-3/16in./360mm (depth)
Weight	Without package: 21lb. 13oz/9.9kg With package: 26lb. 7oz/12kg
Furnished Accessories	FM T-type Antenna 1 Pin Plugs 2 Speaker Plugs 6 Polishing cloth 1 Operating Instructions 1

NOTE: Specifications and the design subject to possible modification without notice due to improvements.

2. FRONT PANEL FACILITIES

SPEAKERS SWITCH

A combination of the power on/off switch and the speaker system selector switch.

POWER OFF ... The equipment is dead.

A Sound comes through the speaker system plugged into the A speaker sockets.

SPKR OFF ... No sound comes from any speaker system. Useful for listening through headphones.

B Sound comes through the speaker system plugged into the B speaker sockets.

C Sound comes through the speaker system plugged into the C speaker sockets.

A + B Both A and B speaker systems are energized.

A + C Both A and C speaker systems are energized.

PHONES JACK

Use this to plug in stereo headphones.

A full selection of high-performance headphones is available from Pioneer.

BASS & TREBLE CONTROLS

Control bass and treble. Turning each control clockwise from the FLAT position will boost the tone, and turning it counterclockwise will diminish the tone.

FILTER SWITCHES

LOW: Setting this switch to ON will eliminate low frequency noises, such as record rumble, hum, or other interference. The switch is normally set to OFF unless the filter is required.

HIGH: Setting this switch to ON will eliminate high frequency noises, such as record scratch, hiss static noise from fluorescent lamps, or other interference. The switch is normally set to OFF unless the filter is required.

FM MUTING SWITCH

This switch is used to suppress much noise between FM stations while tuning.

In a fringe area, however, this switch should be kept off in order not to suppress the desired station signal at the same time.

BALANCE CONTROL

This control balances the volume of the left and right speaker systems. Where the volume from the right-hand speakers is too low, turn it to the right (clockwise). Where the volume from the left-hand speakers is too low, turn it to the left (counterclockwise).

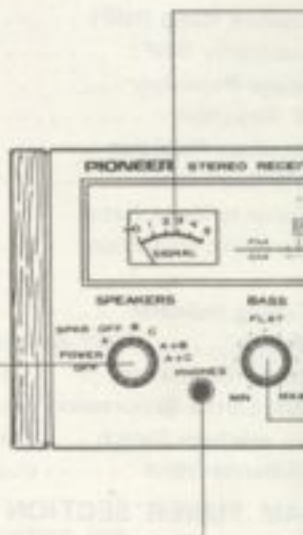

VOLUME CONTROL

To increase the volume, turn it to the right.

LOUDNESS SWITCH

To listen to quieter sound, set this switch to the low and high notes. For normal listening, set it to the center.

TAPE MONITOR SWITCHES

These switches are set to ON for recording or playback of recorded tapes with the following exceptions:

- 1 - This switch is set to ON for MON jacks and TAPE connector.
- 2 - This switch is set to ON for MON jacks and TAPE 2 R.

NOTE: For a normal record playback, the switches are set to the OFF position. This switch will not be produced in the future.

SIGNAL METER

Meter for indicating receiving signal strength.

STEREO INDICATOR

This indicator will light up when the broadcast is in stereo.

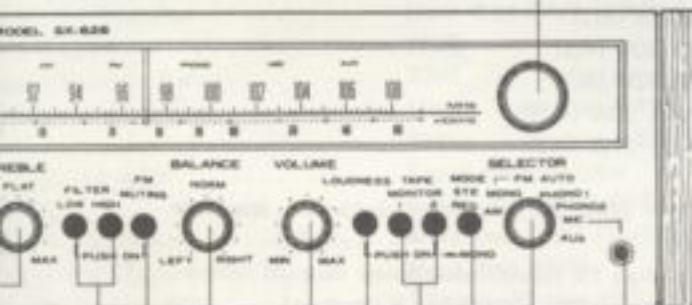

TUNING KNOB

Used to select desired stations.

MIC JACK

Accepts the plug of the microphone. Use a high-impedance, dynamic microphone with a standard plug.

SELECTOR SWITCH

This switch is used for choosing the program source.

- AM AM reception.
- FM MONO . . . FM monophonic reception only.
- FM AUTO . . . FM reception by automatic switching for either stereo or monophonic program.
- PHONO 1 . . . For playing records on a turntable plugged into the PHONO 1 jacks.
- PHONO 2 . . . Same as above, for PHONO 2 jacks.
- MIC Microphone sound can be reproduced.
- AUX For playing signals fed to the AUX jacks.

MODE SWITCH

- STEREO: When set to STEREO, stereo sound is present.
- MONO: When set to MONO, the left and right channel signals blend into monophonic sound.

3. CONNECTION DIAGRAM

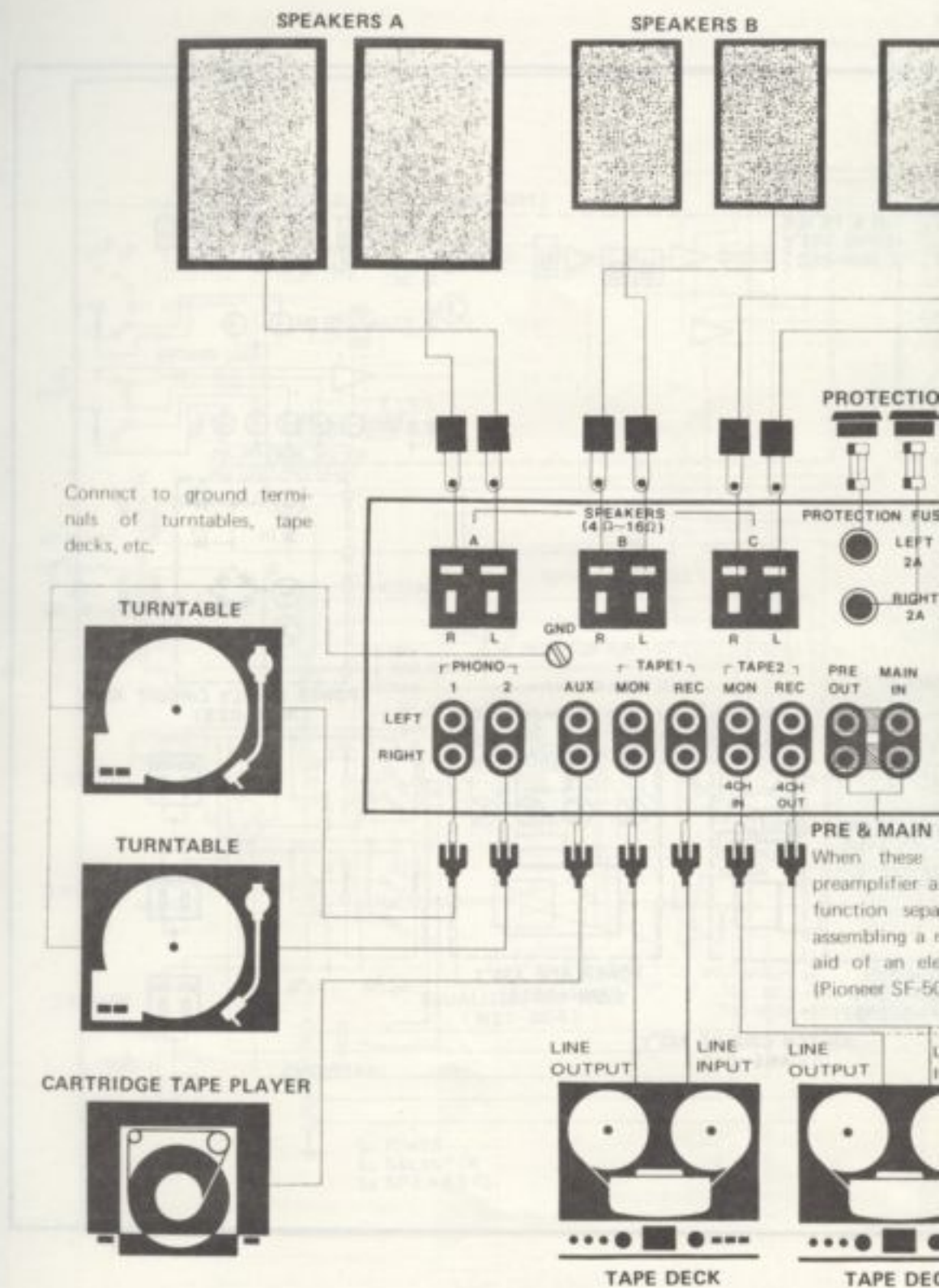

A BLOCK DIAGRAM

MAKERS C

FM OUTDOOR ANTENNA

USE 2A

300Ω FEEDER

75Ω
COAXIAL
CABLE

FM T-TYPE ANTENNA

AM ANTENNA

M FERRITE ANTENNA

FM ANT 75Ω UNBAL 300Ω BAL GND AM ANT

REC/PB

- AC OUTLETS -
SWITCHED UNSWITCHED

GROUND

GS

POWER CORD

FUSE 2A

AC OUTLETS

120V model 5V model
2A 2A 110V 1A 220V
120V 240V
130V

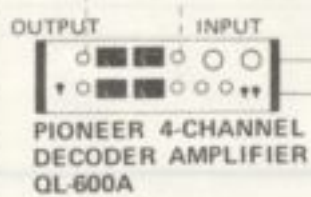

REAR SPEAKERS

With the 4-channel decoder amplifier QL-600A and two more speakers (separately available), a 4-channel stereo system can be assembled as shown in this illustration.

4. BLOCK DIAGRAM

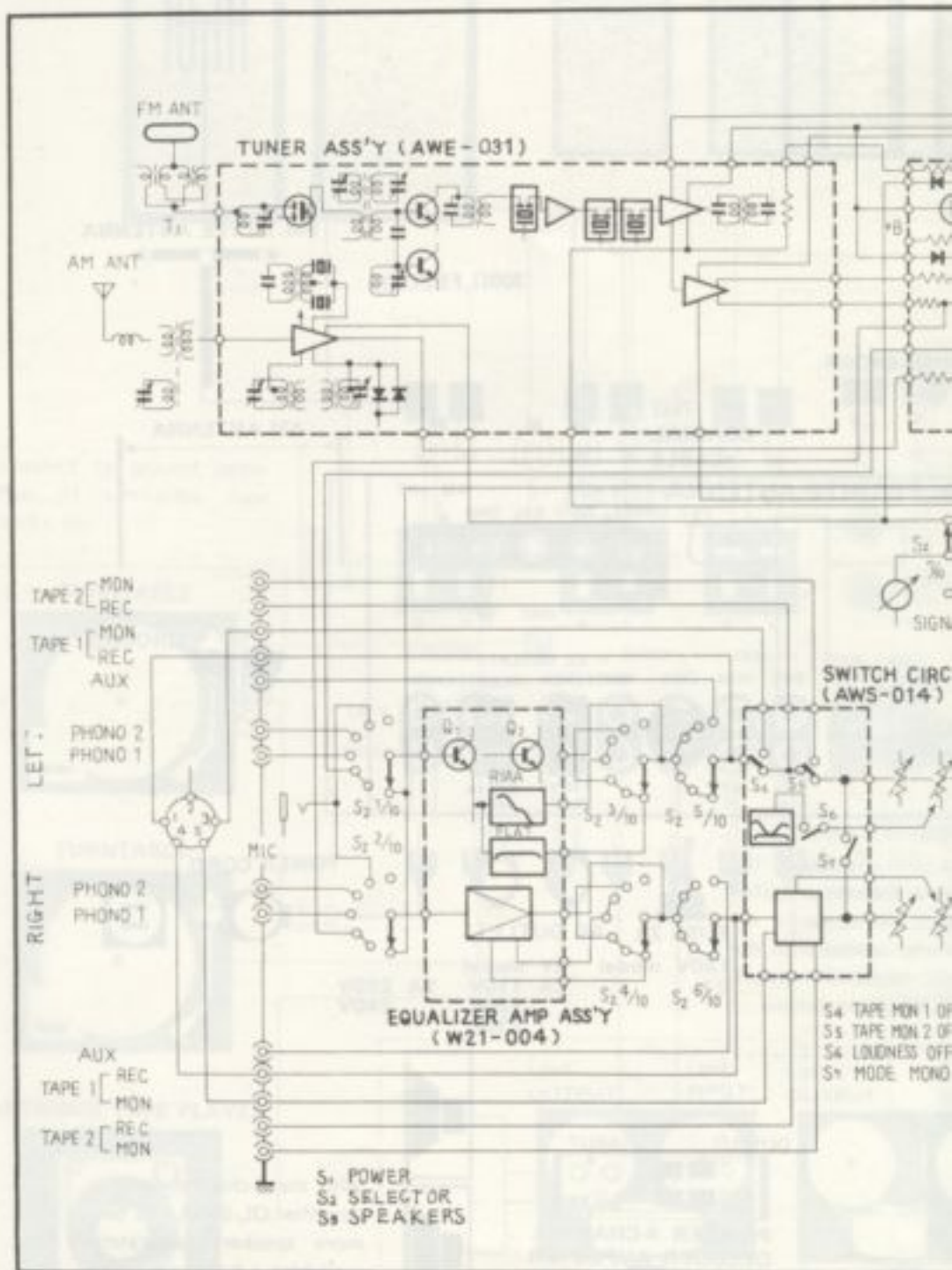

EX-228
 CONNECTION DIAGRAM

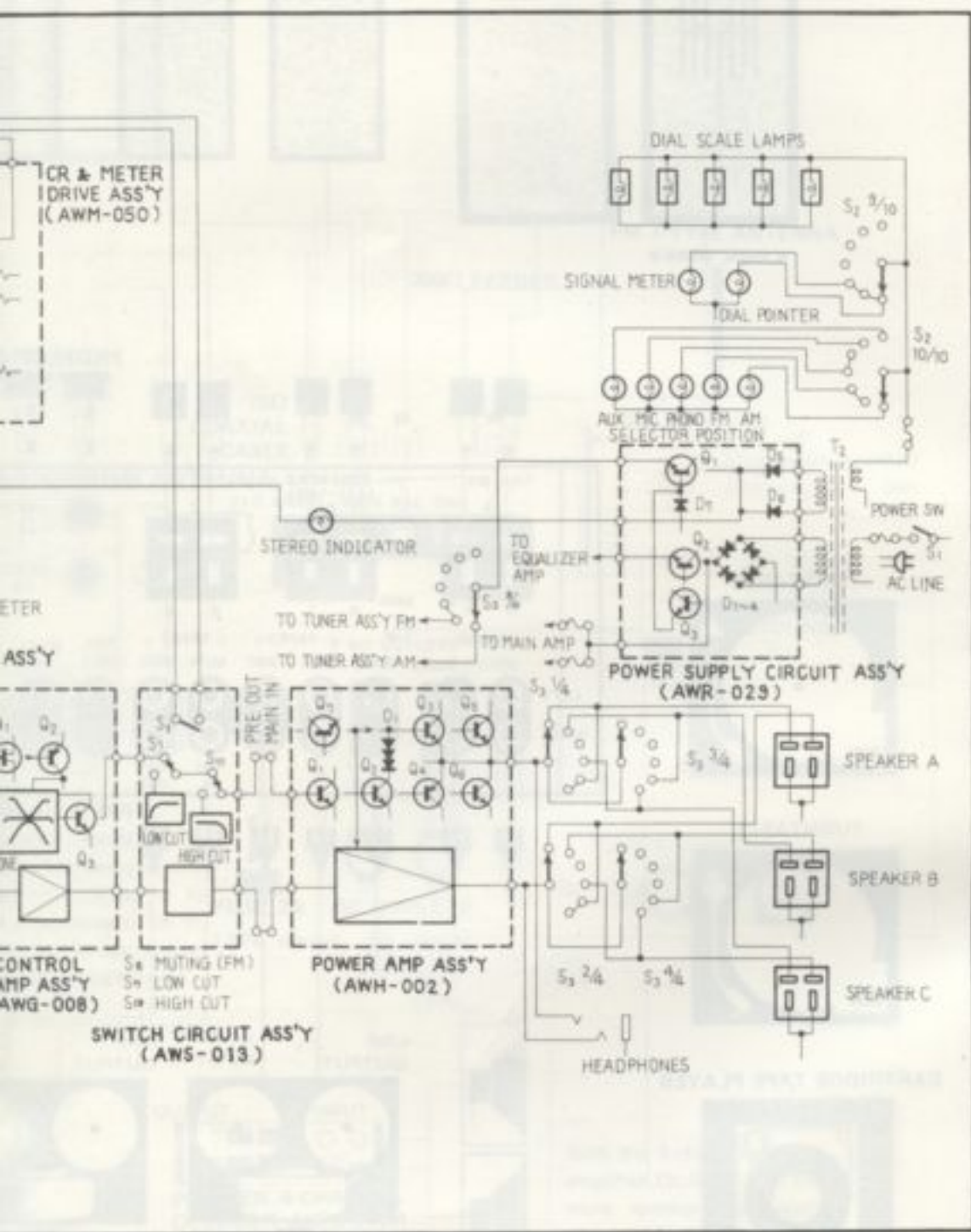

5. DISASSEMBLY

1. Remove 4 screws from the sides of the wooden case. Pull the case backward off from the receiver housing.
2. Pull off all knobs, then remove nuts and washers from shafts and remove 2 screws from top of front panel. The front panel can now be removed.
3. The bottom plate can be removed after loosening the 7 screws.

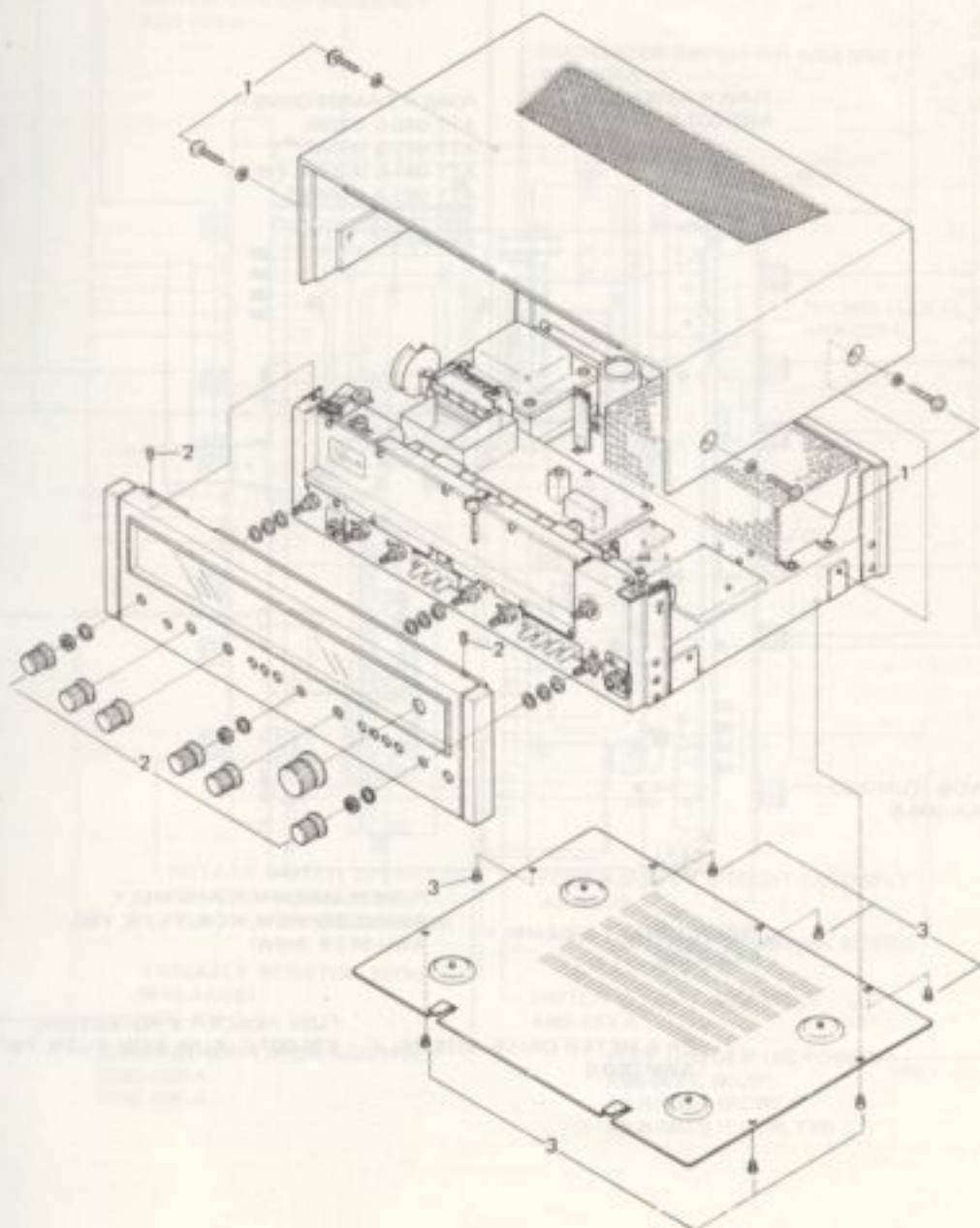

6. PARTS AND P.C. BOARD LOCATION

6.1 TOP VIEW

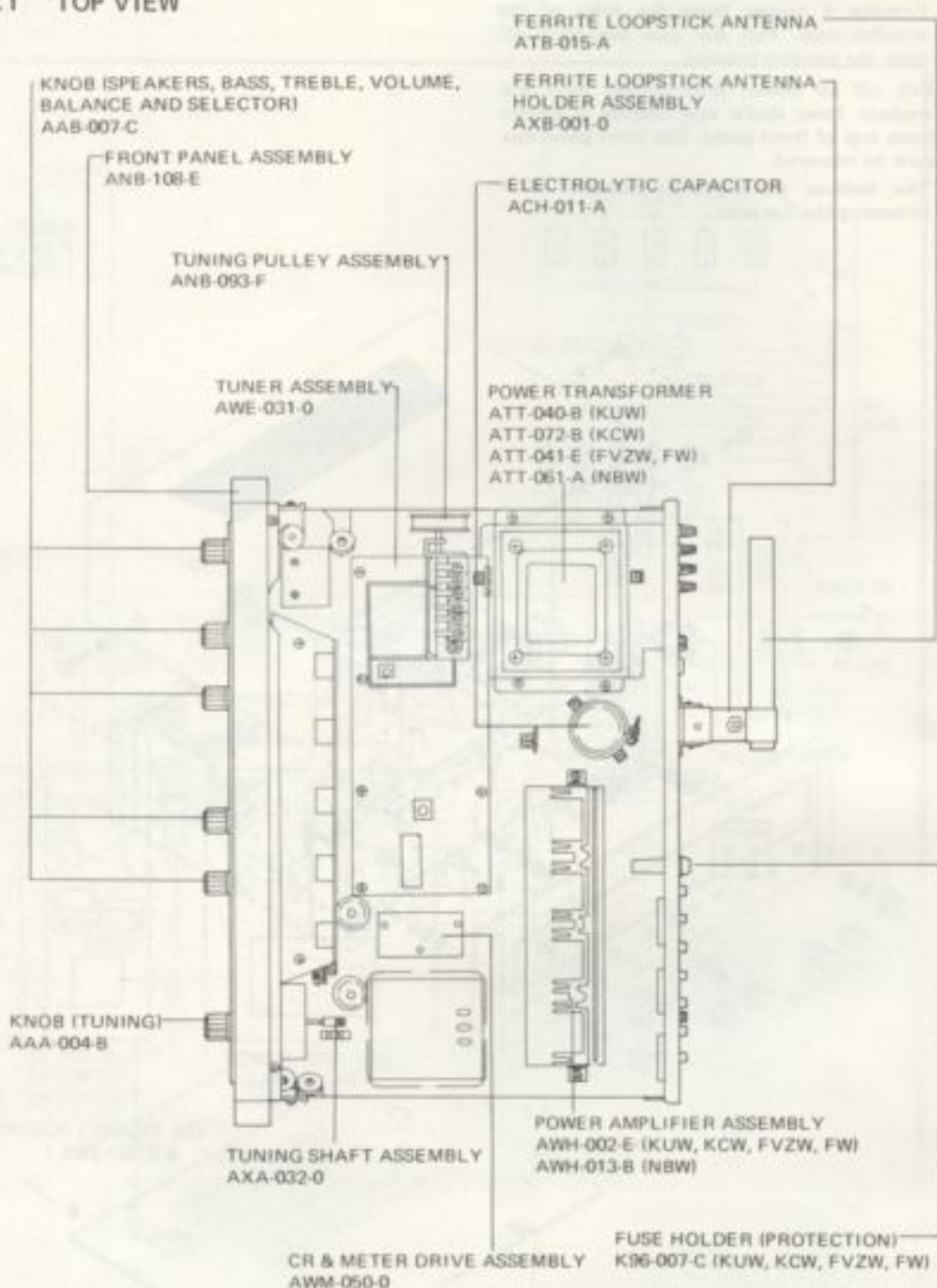

6.2 BOTTOM VIEW

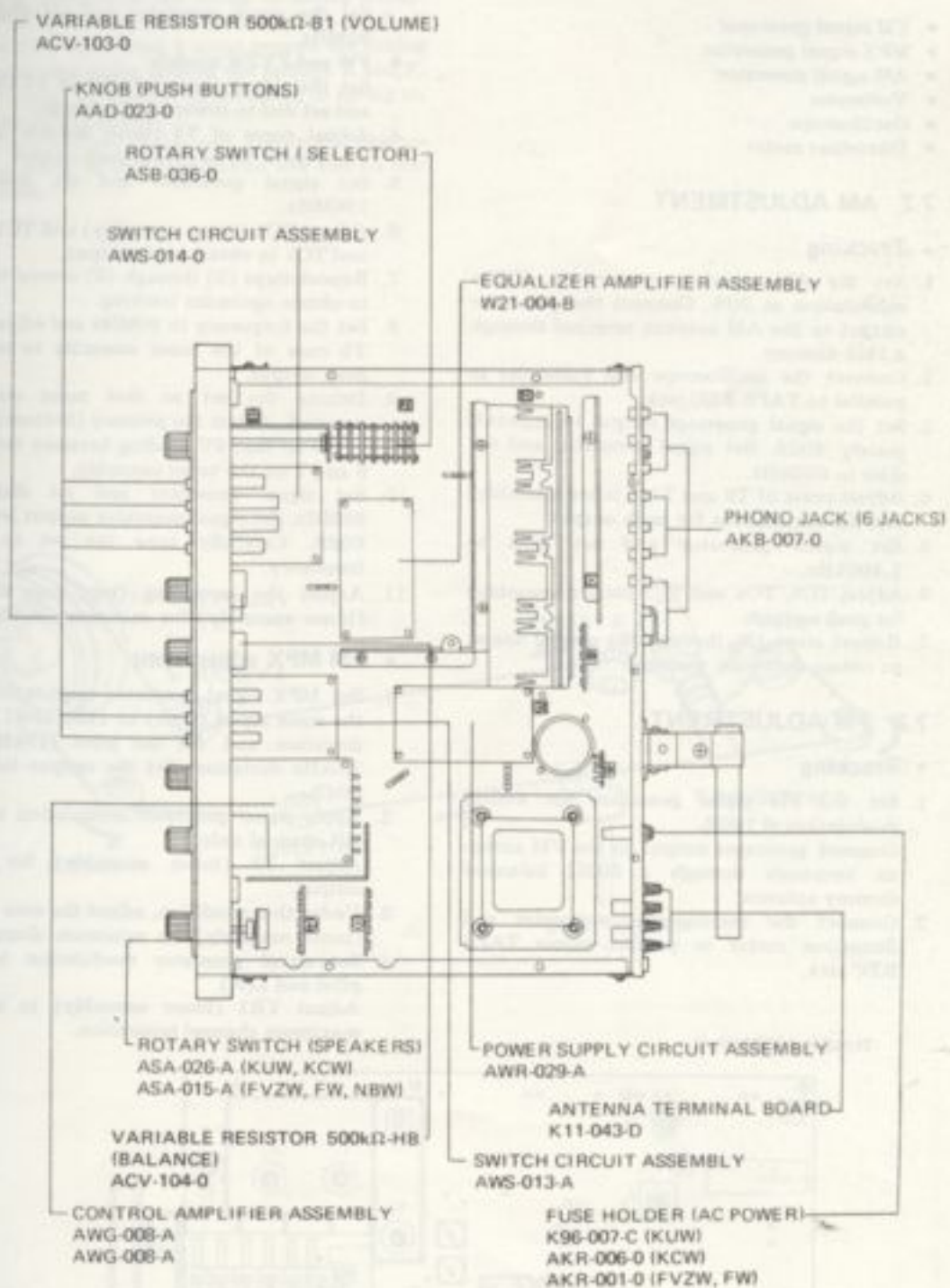

7. ALIGNMENT PROCEDURE

7.1 REQUIRED MEASURING INSTRUMENTS

- FM signal generator
- MPX signal generator
- AM signal generator
- Voltmeter
- Oscilloscope
- Distortion meter

7.2 AM ADJUSTMENT

• Tracking

1. Set the AM signal generator for 400Hz modulation at 30%. Connect the generator output to the AM antenna terminal through a 1k Ω dummy.
2. Connect the oscilloscope and voltmeter in parallel to TAPE REC jack.
3. Set the signal generator output to approximately 30dB. Set signal generator and set dials to 600kHz.
4. Adjust cores of T9 and T10 (tuner assembly) and the bar antenna for peak output.
5. Set signal generator and set dials to 1,400kHz.
6. Adjust TC5, TC6 and TC7 (tuner assembly) for peak output.
7. Repeat steps (3) through (6) several times, to obtain optimum tracking.

7.3 FM ADJUSTMENT

• Tracking

1. Set the FM signal generator for 400Hz modulation at 100%. Connect generator output to the FM antenna terminals through a 300 Ω balanced dummy antenna.
2. Connect the oscilloscope, voltmeter and distortion meter in parallel across TAPE REC jack.

3. Set the signal generator output level to 8~10dB.

• KCW, K UW and NBW models:

Set the signal generator and set dials to 90MHz.

• FW and FVZW models:

Set the signal generator dial to 87.4MHz, and set dial to lower and (left side)

4. Adjust cores of T4 (tuner assembly) and T1, T2 and T3 to obtain peak output.
5. Set signal generator and set dials to 106MHz.
6. Adjust TC4 (tuner assembly) and TC1, TC2, and TC3 to obtain peak output.
7. Repeat steps (3) through (6) several times, to obtain optimum tracking.
8. Set the frequency to 90MHz and adjust the T5 core of the tuner assembly to obtain peak output.
9. Detune the set so that noise only is received. Adjust the primary (bottom) core of T6 so that 0V reading between terminals 6 and 7 on the tuner assembly.
10. Set signal generator and set dials to 98MHz. Set signal generator output level to 60dB. Carefully tune the set to this frequency.
11. Adjust the secondary (top) core of T6 (tuner assembly) for minimum distortion.

• FM MPX adjustment

1. Set MPX signal generator modulation for the main signal (L+R) to 1kHz at 67.5kHz deviation and for the pilot (19kHz) at 7.5kHz deviation. Set the output level to 60dB.
2. Apply signal generator modulation to the left channel only. Adjust T8 (tuner assembly) for peak output.
3. Under this condition, adjust the core of T5 (tuner assembly) for minimum distortion.
4. Set signal generator modulation to the pilot and L(R). Adjust VR1 (tuner assembly) to obtain maximum channel separation.

TUNER ASSEMBLY

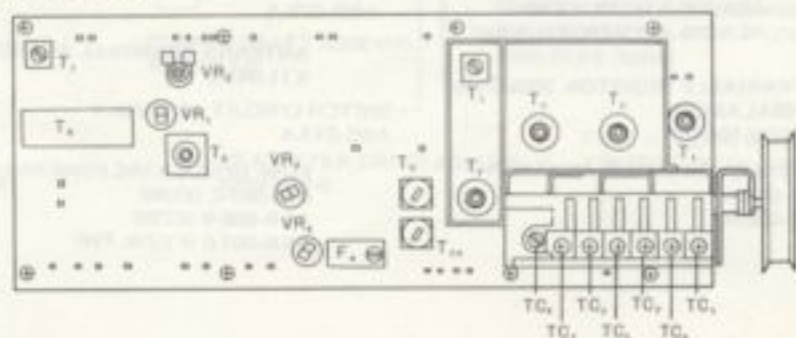

8. DIAL CORD STRINGING

- Set the tuning capacitor to minimum capacitance.
- Tie one end of the string to tuning pulley.
- Pull the string around the pulleys A, B, C and D, then wind 3 turns around the tuning pulley.
- Lead the string around the pulleys E and F.
- Finally, tie the end of the string to spring on the tuning pulley.
- Tune receiver to low end. Fasten dial pointer to string so that it indicates low end on dial scale.

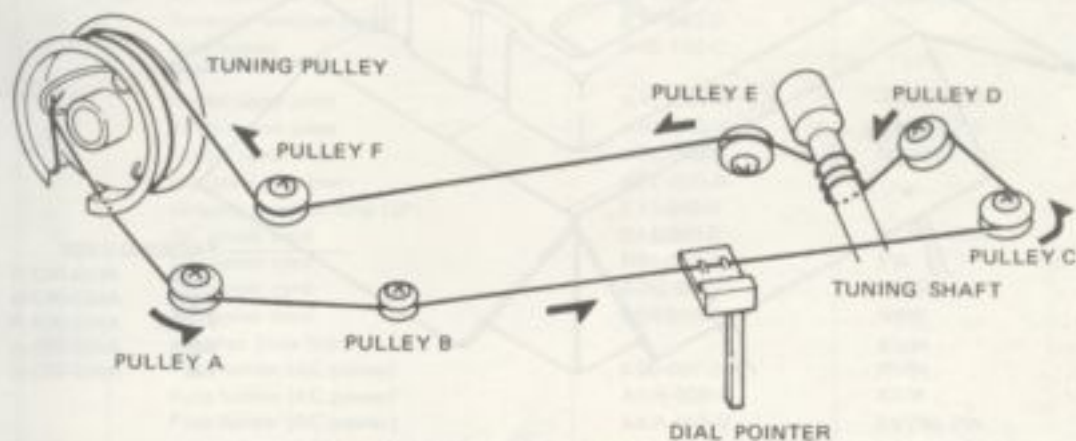

Part No.	Description	Quantity	Part No.	Description	Quantity
1	String	1	1	String	1
2	String	1	2	String	1
3	String	1	3	String	1
4	String	1	4	String	1
5	String	1	5	String	1
6	String	1	6	String	1
7	String	1	7	String	1
8	String	1	8	String	1
9	String	1	9	String	1
10	String	1	10	String	1
11	String	1	11	String	1
12	String	1	12	String	1
13	String	1	13	String	1
14	String	1	14	String	1
15	String	1	15	String	1
16	String	1	16	String	1
17	String	1	17	String	1
18	String	1	18	String	1
19	String	1	19	String	1
20	String	1	20	String	1
21	String	1	21	String	1
22	String	1	22	String	1
23	String	1	23	String	1
24	String	1	24	String	1
25	String	1	25	String	1
26	String	1	26	String	1
27	String	1	27	String	1
28	String	1	28	String	1
29	String	1	29	String	1
30	String	1	30	String	1
31	String	1	31	String	1
32	String	1	32	String	1
33	String	1	33	String	1
34	String	1	34	String	1
35	String	1	35	String	1
36	String	1	36	String	1
37	String	1	37	String	1
38	String	1	38	String	1
39	String	1	39	String	1
40	String	1	40	String	1
41	String	1	41	String	1
42	String	1	42	String	1
43	String	1	43	String	1
44	String	1	44	String	1
45	String	1	45	String	1
46	String	1	46	String	1
47	String	1	47	String	1
48	String	1	48	String	1
49	String	1	49	String	1
50	String	1	50	String	1

9. PACKING METHOD AND PART NUMBERS

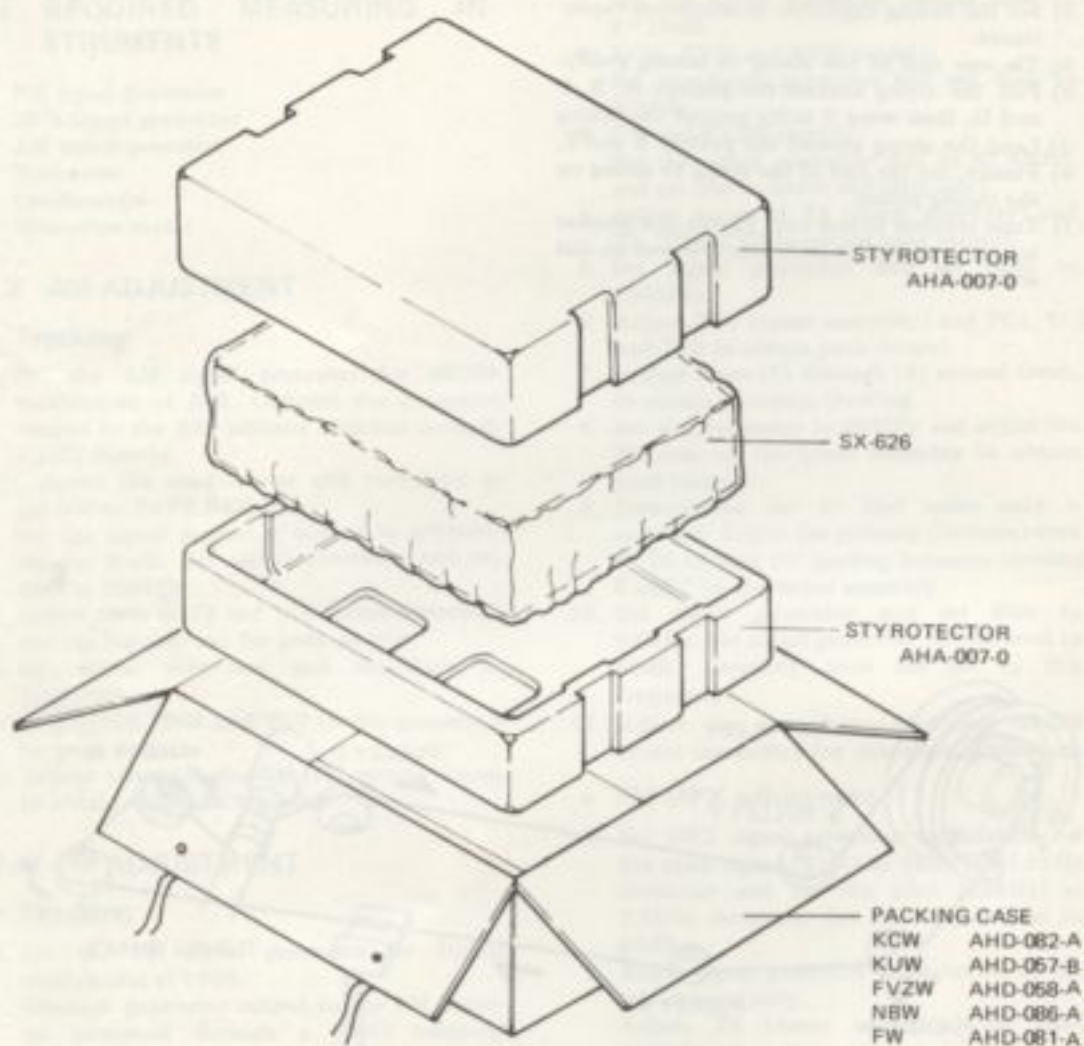

10. EXPLODED VIEW AND PARTS LIST

Parts List of Exploded View

NOTICE: Any parts asterisked (*) are subject to being not supplied.

Key No.	Description	Part No.
1*	Lamp cover	ANH-140-0
2	Pilot lamp socket	K91-005-A
3	Pilot lamp 8V, 0.3A (meter)	E22-017-0
4	Signal meter	AAW-005-0
5	Dial pointer assembly	AAF-007-C
6	Dial scale	AAG-057-0
7*	Dial scale-held metal	ANF-020-B
8	Lamp board assembly	AWX-010-A
9	Pilot lamp 8V, 0.3A (dial scale)	E22-017-0
10	Pilot lamp 6V, 30mA (stereo indicator)	AEL-006-0

Key No.	Description	Part No.	
11*	Lamp box	AEC-014-A	
12*	Wire clip	AEC-004-0	
13	Terminal strip (2P)	AKC-015-0	KUW
	Terminal strip (2P)	K13-043-A	KCW, FVZW, FW, NBW
14*	Pulley shaft	M49-025-E	
15*	Pulley	AEC-006-0	
16*	Pulley-held metal	ANG-091-0	
17	AC socket-held metal	M49-127-A	KUW, KCW, FVZW, FW
18	AC socket	AKP-002-0	KUW, KCW, FW
	AC socket	K82-012-A	FVZW
19	Terminal strip (1L2P)	AKC-018-0	
20	Tuning pulley assembly	AXA-015-A	
21	Tuner assembly	AWE-031-0	
22*	Sub-chassis-B	ANA-054-0	
23*	Sub-chassis-A	ANA-053-0	
24	Power transformer	ATT-040-B	KUW
	Power transformer	ATT-072-B	KCW
	Power transformer	ATT-041-E	FVZW, FW
	Power transformer	ATT-061-A	NBW
25	Ground terminal strip (2P)	K13-048-0	
26	Electrolytic capacitor 3,300 μ F, 63V	ACH-011-A	
27	CR & meter drive assembly	AWM-050-0	
28*	P.C. board holder	AEB-019-0	KUW
	P.C. board holder	B21-008-A	KCW, FW, FVZW, NNW
29	Antenna terminal board	K11-043-D	
30*	Wire holder	M45-105-C	
31*	Model name plate	AAL-047-A	KUW, KCW
	Model name plate	AAL-048-A	FW, FVZW
	Model name plate	ABL-069-0	NBW
32	AC cord grommet	AEC-079-0	
33	Ground terminal strip (2P)	K13-048-0	
34	AC power cord	D11-003-E	KUW, KCW
	AC power cord	D11-002-B	FW
	AC power cord	ADG-004-0	FVZW
	AC power cord	D54-019-0	NBW
35*	Adaptor (fuse holder)		KUW
36	Fuse holder (AC power)	K96-007-C	KUW
	Fuse holder (AC power)	AKR-006-0	KCW
	Fuse holder (AC power)	AKR-001-0	FVZW, FW
37	Ferrite loopstick antenna		
38	Fuse holder (Protection)	K96-007-C	KUW, KCW, FVZW, FW
39	Ferrite loopstick antenna holder assembly	AXB-001-0	
40	Connector (DIN type 5pl)	K93-003-B	
41	Washer	B21-011-0	
42	Screw M4x15	ABA-010-A	
43	Wooden case	AMM-006-C	
44*	Cover (power amplifier)	ANH-131-0	
45	Power amplifier assembly	AWH-002-E	KUW, KCW, FVZW, FW
	Power amplifier-assembly	AWH-013-B	NBW
46	Power amplifier-held metal	ANF-017-0	
47*	Rear panel	ANC-032-E	KUW, KCW
	Rear panel	ANC-027-H	FVZW, FW
	Rear panel	ANC-042-D	NBW
48	Speaker output terminal	K72-028-0	
49	Tuning shaft assembly	AXA-032-0	
50*	Bottom plate	ANE-008-0	

NOTICE: Any parts asterisked (*) are subject to being not supplied.

Key No.	Description	Part No.	
51*	Pulley shaft	M49-025-E	
52*	Pulley	AEC-006-0	
53*	Pulley-held metal	ANG-091-0	
54*	Chassis	ANA-012-J	
55*	Pulley-held metal	ANG-091-0	
56*	Pulley	AEC-006-0	
57*	Pulley shaft	M49-025-E	
58	Ground terminal strip (2P)	K13-048-0	
59*	Shield plate (1)	ANH-044-A	
60			
61	Rotary switch	ASB-038-0	
62*	Wire clip	AEC-004-0	
63	Phone jack (Microphone)	K72-024-0	
64*	Switch-held metal	ANF-019-A	
65	Ground terminal strip (2P)	K13-048-0	
66*	Shield plate (2)	ANH-045-A	
67	Phone jack-A (6 jacks)	AKB-007-0	
68*	P.C. board holder	AEB-019-0	KUW
	P.C. board holder	B21-008-A	KCW, FW, FVZW, NBW
69	Equalizer amplifier assembly	W21-004-B	
70*	P.C. board holder	AEB-019-0	KUW
	P.C. board holder	B21-008-A	KCW, FW, FVZW, NBW
71	Switch assembly	AWS-014-0	
72*	Control amplifier-held metal	ANF-018-0	
73*	P.C. board holder	AEB-019-0	KUW
	P.C. board holder	B21-008-A	KCW, FW, FVZW, NBW
74	Control amplifier assembly	AWG-008-A	
75*	P.C. board holder	AEB-019-0	KUW
	P.C. board holder	B21-008-A	KCW, FW, FVZW, NBW
76	Power supply circuit assembly	AWR-029-A	
77*	Wire clip (B)	AEC-005-0	
78	Variable resistor 500k-B1 (Volume)	ACV-103-0	
79	Variable resistor 500k-HB (Balance)	ACV-104-0	
80*	Shield plate	ANH-139-A	
81*	P.C. board holder	AEB-019-0	KUW
	P.C. board holder	B21-008-A	KCW, FW, FVZW, NBW
82	Switch assembly	AWS-013-A	
83*	Wire clip (B)	AEC-005-0	
84	Phone jack (Headphones)	K72-026-0	
85	Terminal strip (1L4P)	K13-026-A	KUW, KCW, FVZW
86			
87	Rotary switch (Speakers)	ASA-026-A	KUW, KCW
	Rotary switch (Speakers)	ASA-015-A	FW, FVZW, NBW
88*	Sub-panel assembly	AND-016-H	
89	Front panel assembly	ANB-108-E	
90	Knob (Speakers, Bass, Treble)	AAB-007-C	
91	Knob (push switch)	AAD-023-0	
92	Knob (Balance, Volume)	AAB-007-C	
93	Knob (push switch)	AAD-023-0	
94	Knob (Tuning)	AAA-004-B	
95	Knob (Selector)	AAB-007-C	

Exploded View

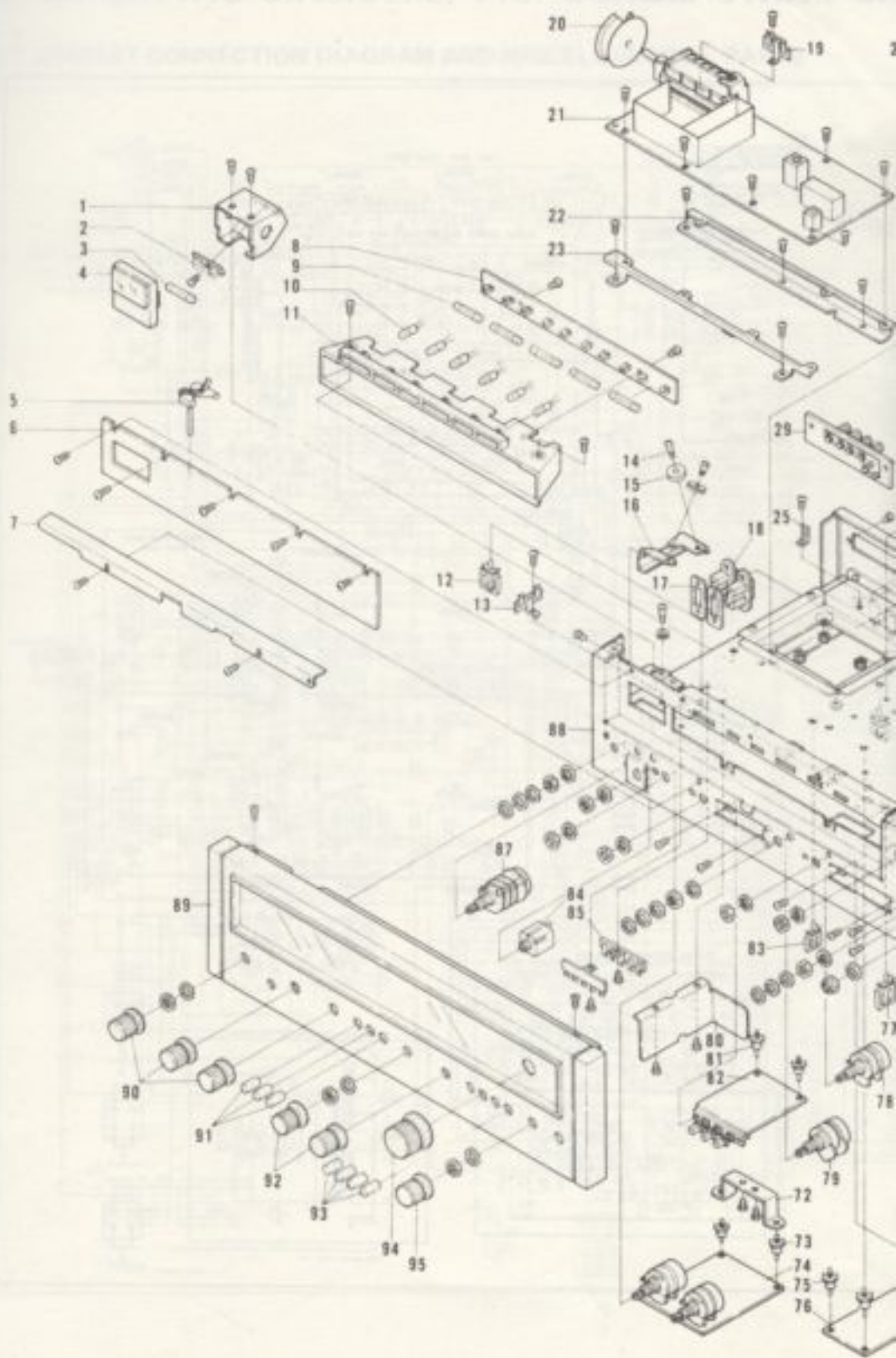

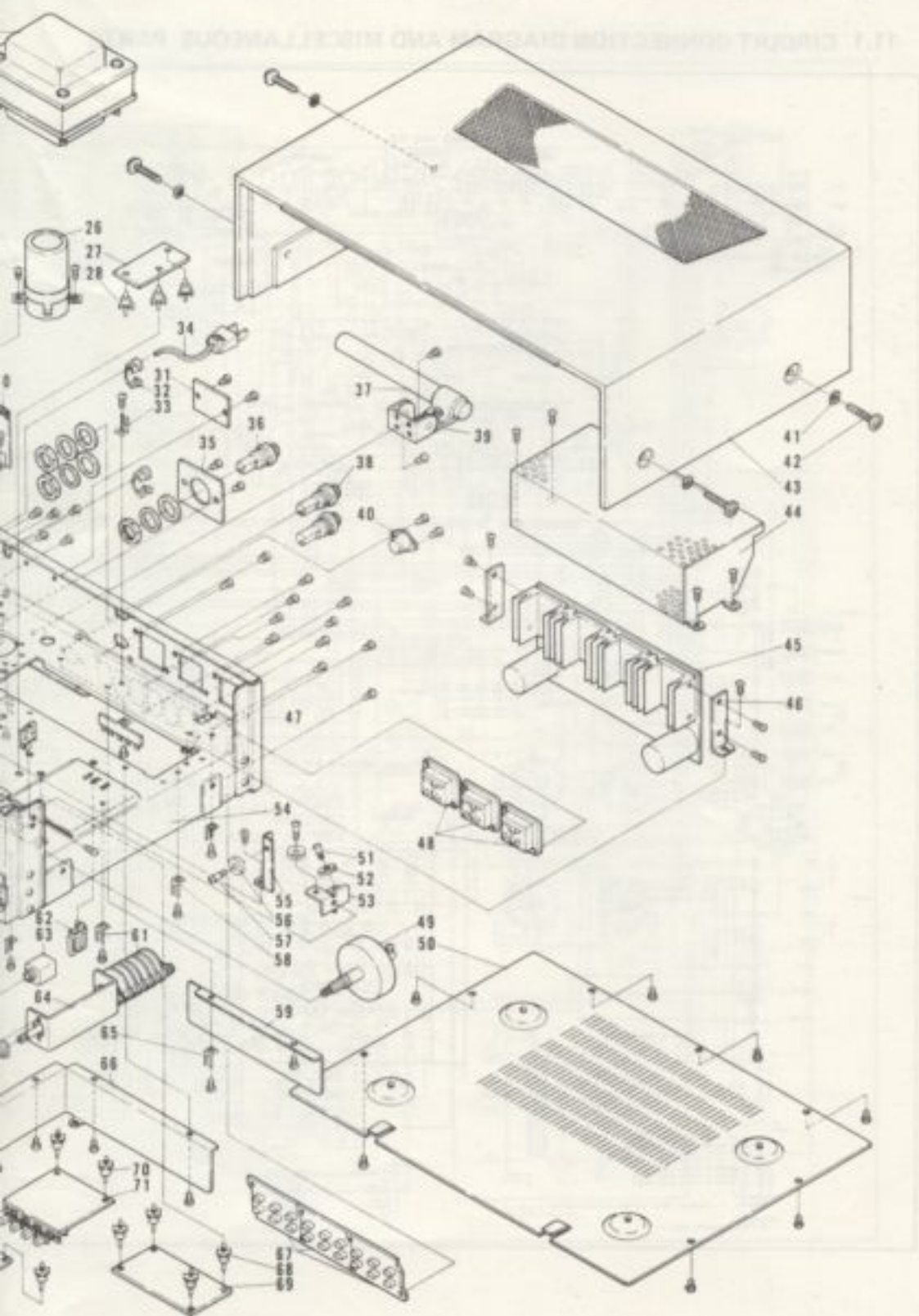

11. SCHEMATIC DIAGRAMS, P.C. BOARD PATTERNS

11.1 CIRCUIT CONNECTION DIAGRAM AND MISCELLANEOUS PARTS

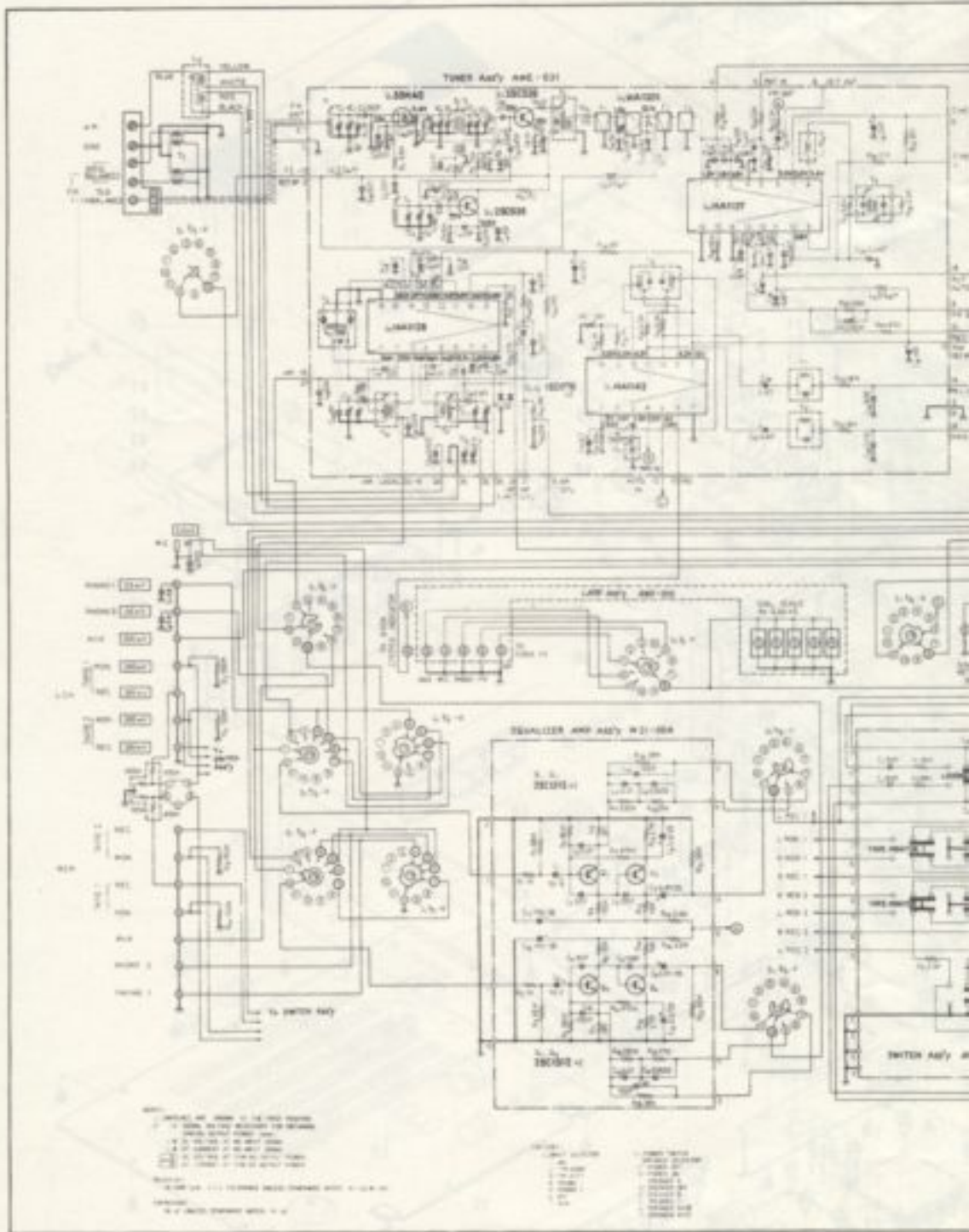

ND PARTS LIST

NOTES:
 1. Resistor values are indicated in ohms, kilohms, or megohms.
 2. Capacitor values are indicated in picofarads, microfarads, or millifarads.
 3. All components are standard unless otherwise indicated.

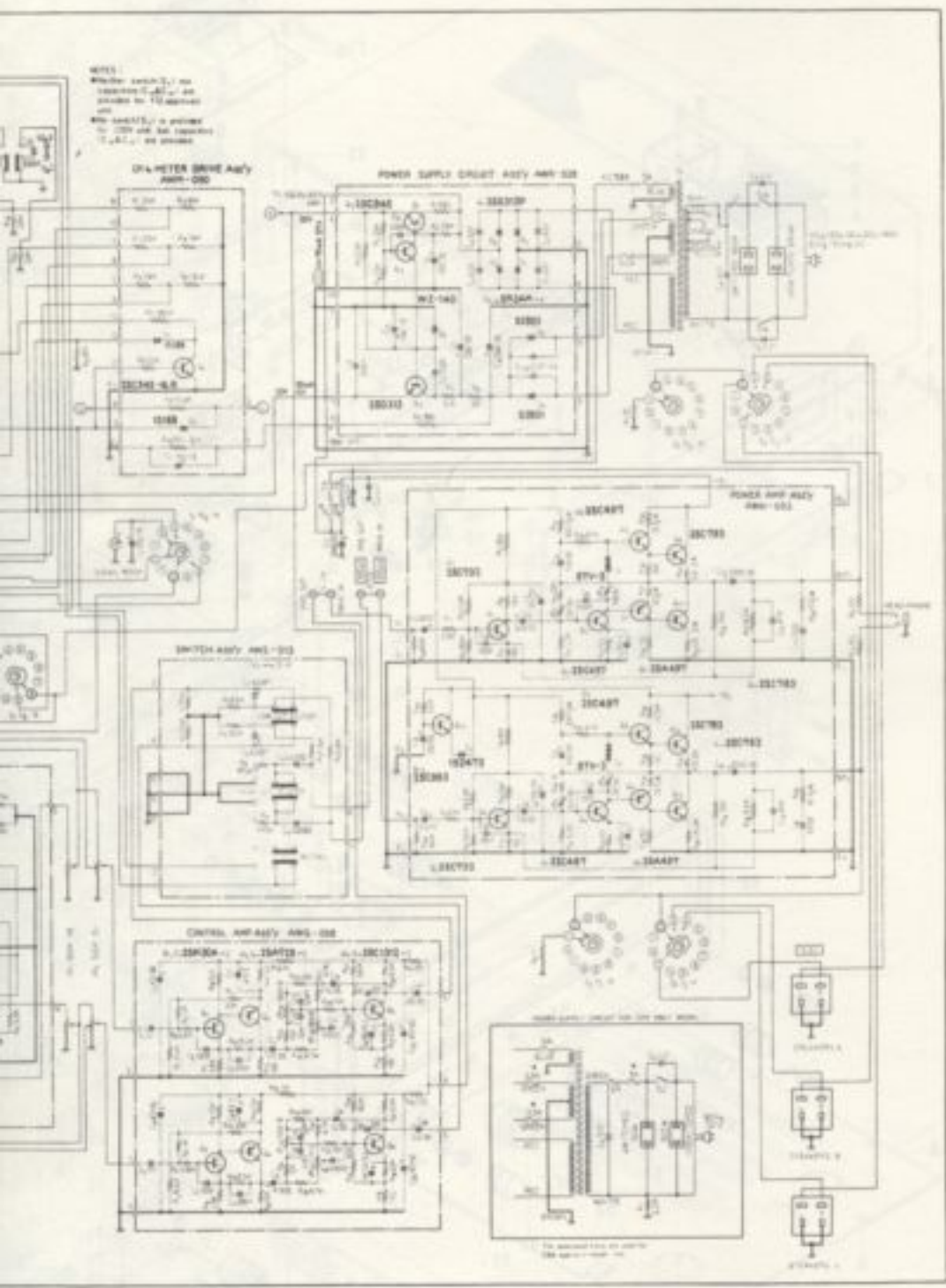

Miscellaneous Parts

- CAPACITORS: IN μ F UNLESS OTHERWISE NOTED p: pF
 • RESISTORS: IN Ω , $\frac{1}{2}$ W UNLESS OTHERWISE NOTED k: k Ω , M: M Ω

CAPACITORS

Symbol	Description	Part No.	
C2	Electrolytic 220 10V	CEB 221P 10	
C3	Electrolytic 3,300 63V	ACH-011-A	
C4	Metallized mylar 0.01 800V	ACE-002-0	KUW
	Ceramic 0.01 250V	ACG-003-0	KCW
	Ceramic 0.01 250V	ACG-001-0	FVZW, FW
C5	Ceramic 0.01 250V	ACG-001-0	KUW, FVZW, FW
	Ceramic 0.01 150V	ACG-002-0	KCW
C6	Ceramic 0.01 250V	ACG-001-0	FVZW, FW
C7	Ceramic 0.01 50V	CKDYF 103Z 50	
C8	Ceramic 0.01 50V	CKDYF 103Z 50	
C9	Ceramic 0.01 50V	CKDYF 103Z 50	
C10	Ceramic 0.01 150V	ACG-002-0	KCW, KUW
	Ceramic 0.01 250V	ACG-001-0	FVZW, FW, NBW
C11	Ceramic 0.01 150V	ACG-002-0	KCW, KUW
	Ceramic 0.01 250V	ACG-001-0	FVZW, FW, NBW
C12	Mylar 0.0082 50V	CGMA 822J 50	KUW, KCW, FW
C13	Mylar 0.0082 50V	CGMA 822J 50	KUW, KCW, FW

RESISTORS

Symbol	Description	Part No.	
R3	Carbon film 150k	RD%PS 154J	
R4	Carbon film 150k	RD%PS 154J	
R5	Carbon film 150k	RD%PS 154J	
R6	Carbon film 150k	RD%PS 154J	
R7	Wire wound 10 5W	RT5B 100K	
R8	Wire wound 10 5W	RT5B 100K	
R9	Wire wound 150 3W	RT3B 151K	
R10	Wire wound 150 3W	RT3B 151K	
R11	Carbon film 2.2M $\frac{1}{2}$ W	RD%PW 225J	KUW, KCW
R12	Carbon film 22 $\frac{1}{2}$ W	RD%PS 220J	
R13	Carbon film 18k	RD%PS 183J	
R14	Carbon film 3.9k	RD%PS 392J	
R15	Carbon film 3.9k	RD%PS 392J	
R16	Carbon film 1M	RD%PS 105J	KUW, KCW
VR1	Variable resistor 500k-HB (Balance)	ACV-104-0	
VR2	Variable resistor 500k-B1 (Volume)	ACV-103-0	

COIL AND TRANSFORMERS

Symbol	Description	Part No.	
L1	RF choke coil	T24-028-A	
L2	Ferrite loopstick antenna	ATB-015-A	
T1	Power transformer	ATT-040-B	KUW
	Power transformer	ATT-072-B	KCW
	Power transformer	ATT-041-E	FVZW, FW
	Power transformer	ATT-061-A	NBW
T2	Balun	T22-025-A	

Continued on the next page

SWITCHES

Symbol	Description	Part No.	
S1	Rotary switch (Selector)	ASB-036-0	
S2	Rotary switch (Speakers)	ASA-026-A	KUW, KCW
	Rotary switch (Speakers)	ASA-015-A	FVZW, FW, NBW
S3	Slide switch (De-emphasis)	S41-022-A	FW

OTHERS

Symbol	Description	Part No.	
	Tuner assembly	AWE-031-0	
	Equalizer amplifier assembly	W21-004-B	
	Control amplifier assembly	AWG-008-A	
	Power amplifier assembly	AWH-002-E	KUW, KCW, FVZW, FW
	Power amplifier assembly	AWH-013-B	NBW
	Switch circuit assembly	AWS-013-A	
	Switch circuit assembly	AWS-014-0	
	CR & meter drive assembly	AWM-050-0	
	Power supply circuit assembly	AWR-029-A	
	Lamp board assembly	AWX-010-A	
	Front panel assembly	ANB-108-E	
	Wooden case	AMM-006-C	
	Dial pointer assembly	AAF-007-C	
	Signal meter	AAW-005-0	
	Knob (push buttons)	AAD-023-0	
	Knob (Speakers, Bass, Treble, Volume, Balance and Selector)	AAB-007-C	
	Knob (Tuning)	AAA-004-B	
	Dial scale	AAG-057-0	
	Phono jack-A (6 jacks)	AKB-007-0	
	Antenna terminal board	K11-043-D	
	Jumper plug (for phono jack)	AKM-005-0	
	Pilot lamp 8V, 50mA (program indicator)	AEL-007-0	
	Pilot lamp 8V, 0.3A (dial scale)	E22-017-0	
	Pilot lamp 6V, 30mA (Stereo indicator)	AEL-006-0	
	Fuse 2A (AC power)	E21-027-0	KUW, KCW
	Fuse 1A (AC power)	E21-004-0	FVZW, FW
	Fuse 3A (protection)	AEK-008-0	KUW, KCW
	Fuse 2A (protection)	E21-036-A	KUW, KCW
	Fuse 3A (protection)	E21-022-0	KCW, FVZW, FW
	Fuse A (protection)	E21-019-A	KCW, FVZW, FW
	Fuse 2A (protection)	E21-029-A	NBW
	Fuse 0.5A (protection)	AEK-014-0	NBW
	Fuse 1A (protection)	E21-031-0	NBW
	Fuse 5A (protection)	AEK-015-0	NBW
	Compound part for REC jack	W52-004-0	
	AC socket	AKP-002-0	KUW, KCW, FW
	AC socket	K82-012-A	FVZW
	Speaker output terminal	K72-028-0	
	Phone jack (Headphones)	K72-026-0	
	Phone jack (Microphone)	K72-024-0	
	Fuse holder	K92-005-A	

Symbol	Description	Part No.	
	Connector (DIN type 5P)	K93-003-B	
	Fuse holder (AC power and Protection)	K96-007-C	KUW, KCW, FVZW, FW
	Fuse holder (AC power)	AKR-006-0	KCW
	Fuse holder (AC power)	AKR-001-0	FVZW, FW
	Fuse holder (Protection)	K91-008-0	NBW
	FM T-type antenna	D52-013-0	
	Fuse 2A (AC power)	E21-005-0	FVZW, FW
	Speaker plug	K72-007-B	KUW, FVZW, FW, NBW
	Polishing cloth	E33-009-B	
	Packing case	AHD-057-B	KUW
	Packing case	AHD-062-A	KCW
	Packing case	AHD-058-A	FVZW
	Packing case	AHD-081-A	FW
	Packing case	AHD-085-A	NBW
	AC power cord	D11-003-E	KUW, KCW
	AC power cord	ADG-004-0	FVZW
	AC power cord	D11-002-B	FW
	AC power cord	D54-019-0	NBW
	Operating instructions	ARB-044-E	KUW, KCW, FVZW, FW
	Operating instructions	ARB-053-A	NBW
	Binding post (for ground)	B11-012-A	

11.2 TUNER ASSEMBLY (AWE-031-0)

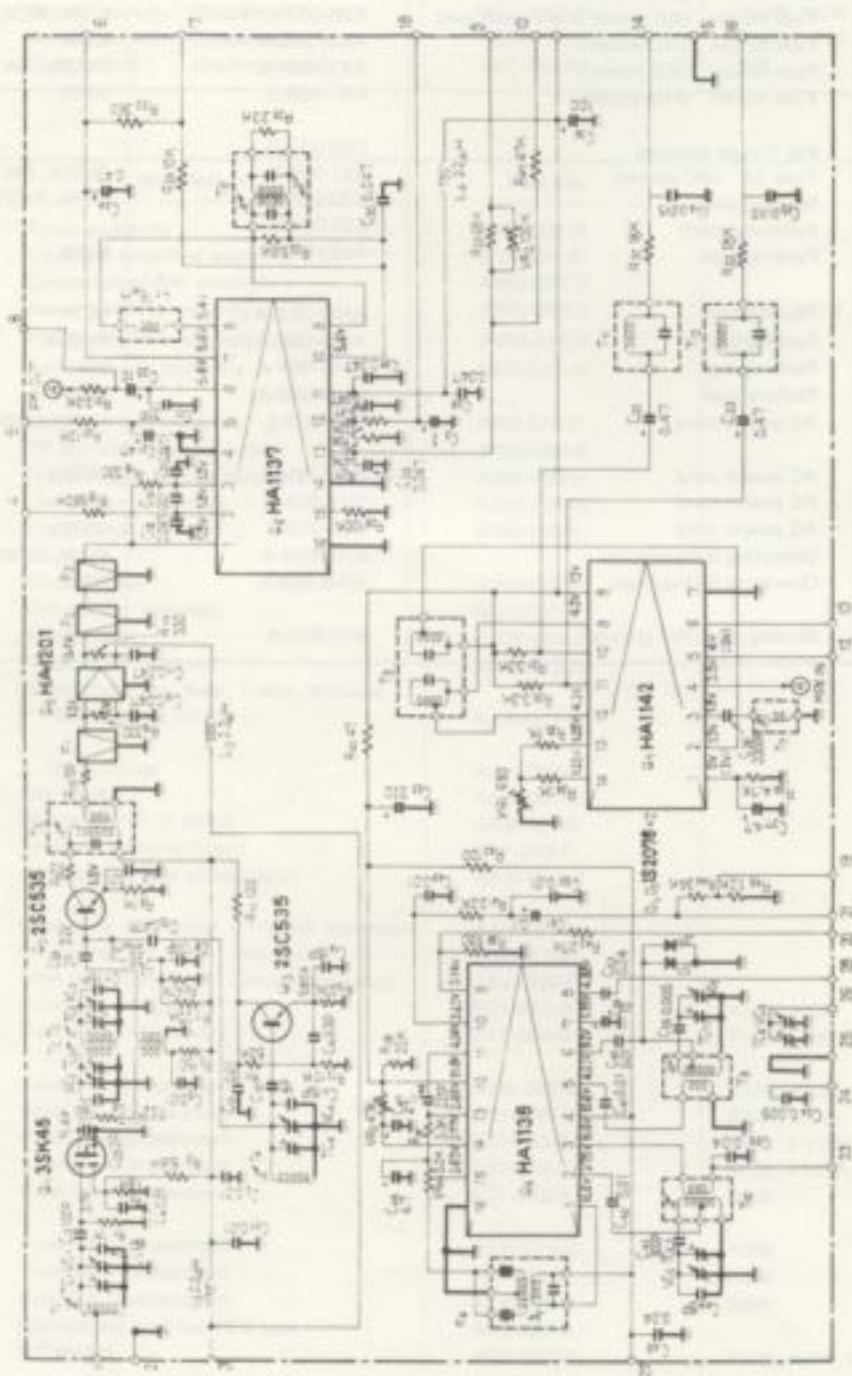

Foil Side

3SK45



2SC535



HA1142

HA1137
HA1138

HA1201

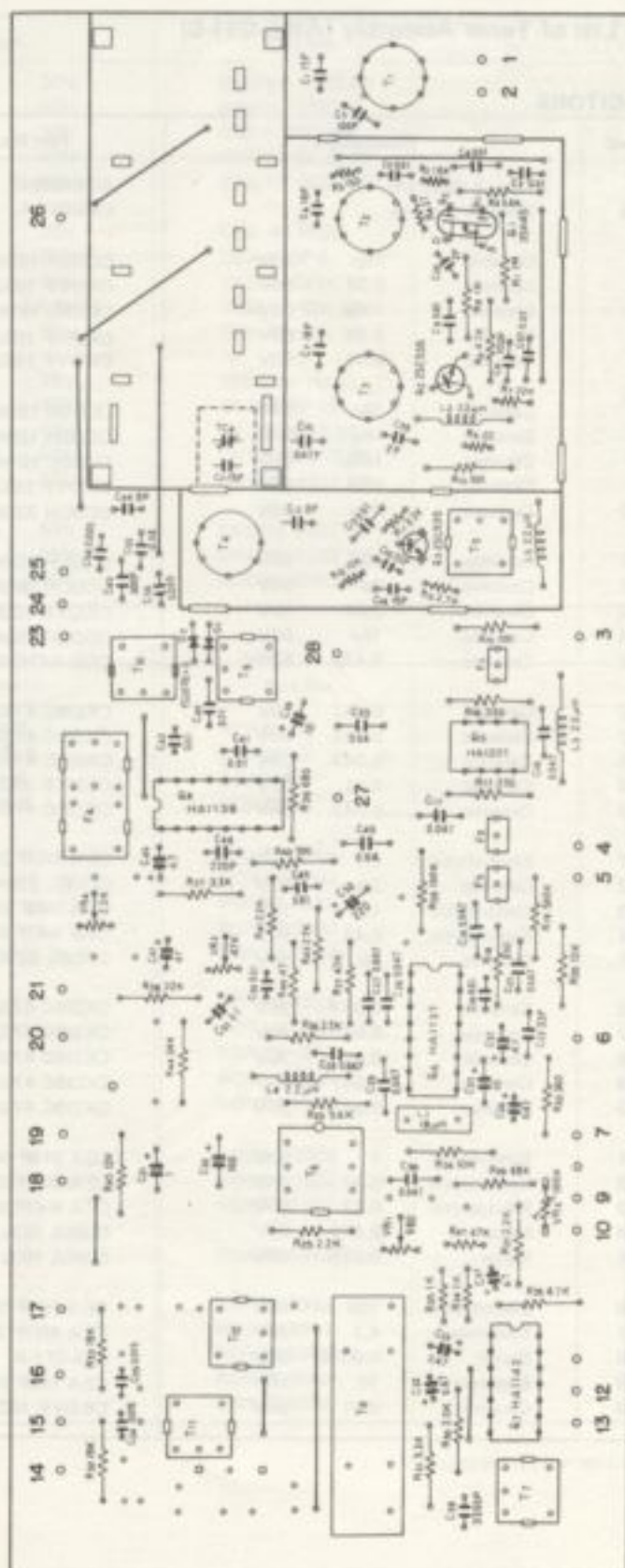
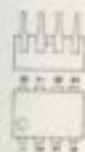

Parts List of Tuner Assembly (AWE-031-0)

CAPACITORS

Symbol	Description			Part No.
VC	Tuning capacitor			ACK-006-0
TC4	Ceramic trimmer			C43-007-A
C1	Ceramic	15p	50V	CCDSH 150K 50
C2	Ceramic	0.01	50V	CKDYF 103Z 50
C3	Ceramic	100p	50V	CCDSL 101K 50
C4	Ceramic	0.01	50V	CKDYF 103Z 50
C5	Ceramic	0.01	50V	CKDYF 103Z 50
C6	Ceramic	18p	50V	CCDSH 180K 50
C7	Ceramic	18p	50V	CCDSH 180K 50
C8	Ceramic	100p	50V	CCDSL 101K 50
C9	Ceramic	0.01	50V	CKDYF 103Z 50
C10	Ceramic	33p	50V	CCDCH 330K 50
C11	Ceramic	15p	50V	CCDLH 150K 50
C12	Ceramic	8p	50V	CCDCH 08DF 50
C13	Ceramic	0.01	50V	CKDYB 103K 50
C14	Ceramic	15p	50V	CCDCH 150K 50
C15	Ceramic	0.47p	500V	CGB R47K 500
C16	Ceramic	0.047	25V	CKDBC 473Z 25
C17	Ceramic	0.047	25V	CKDBC 473Z 25
C18	Ceramic	0.047	25V	CKDBC 473Z 25
C19	Ceramic	0.01	50V	CKDYF 103Z 50
C20	Ceramic	0.047	25V	CKDBC 473Z 25
C21	Electrolytic	4.7	25V	CEA 4R7P 25
C22	Ceramic	33p	50V	CCDSL 330K 50
C23	Electrolytic	10	16V	CEA 100P 16
C24	Electrolytic	0.47	50V	CEA R47P 50
C25	Ceramic	2p	50V	CCDSL 020C 50
C26	Ceramic	0.047	25V	CKDBC 473Z 25
C27	Ceramic	0.047	25V	CKDBC 473Z 25
C28	Ceramic	0.047	25V	CKDBC 473Z 25
C29	Ceramic	0.047	25V	CKDBC 473Z 25
C30	Ceramic	0.047	25V	CKDBC 473Z 25
C31	Electrolytic	1	50V	CEA 010P 50
C32	Electrolytic	0.47	50V	CEA R47P 50
C33	Electrolytic	0.47	50V	CEA R47P 50
C34	Mylar	0.015	50V	COMA 153J 50
C35	Mylar	0.015	50V	COMA 153J 50
C36	Electrolytic	100	16V	CEA 101P 16
C37	Electrolytic	4.7	25V	CEA 4R7P 25
C38	Styrol	0.0033	50V	C15-011-A
C39	Electrolytic	10	16V	CEA 100P 16
C40	Ceramic	0.01	50V	CKDYF 103Z 50

Symbol	Description	Part No.
C41	Ceramic 0.01 50V	CKDYF 103Z 50
C42	Mylar 0.01 50V	QOMA 103K 50
C43	StyroI 300p 50V	QOSA 301J 50
C44	Ceramic 8p 50V	CCDXL 080F 50
C45	Ceramic 0.04 50V	CKDYF 403Z 50
C46	Electrolytic 4.7 25V	CEA 4R7P 25
C47	Electrolytic 47 6V	CEA 470P 6
C48	Ceramic 220p 50V	CCDSL 221K 50
C49	Mylar 0.01 50V	QOMA 103K 50
C50	Mylar 0.01 50V	QOMA 103K 50
C51	Electrolytic 0.1 25V	CSSA 0R1M 25
C52	Electrolytic 220 16V	CEA 221P 16
C53	Ceramic 0.04 50V	CKDY 403Z 50
C54	Ceramic 0.005 50V	CKDYF 502Z 50
C55	Ceramic 0.04 50V	CKDYF 403Z 50
C56	Ceramic 0.005 50V	CKDYF 502Z 50
C57	Ceramic 0.01 50V	CKDYF 103Z 50
C58	Ceramic 2p 50V	CCDSL 020C 50

RESISTORS

Symbol	Description	Part No.
VR1	Variable resistor 680-B	ACP-013-0
VR2	Variable resistor 100k-B	ACP-021-0
VR3	Variable resistor 47k-B	C92-048-0
VR4	Variable resistor 2.2k-B	ACP-001-0
R1	Carbon film 1M	RD%PS 106J
R2	Carbon film 1.8k	RD%VS 182J
R3	Carbon film 5.6k	RD%PS 562J
R4	Carbon film 27	RD%VS 270J
R5	Carbon film 150	RD%VS 151J
R6	Carbon film 4.7k	RD%PS 472J
R7	Carbon film 22k	RD%VS 223J
R8	Carbon film 1k	RD%PS 102J
R9	Carbon film 22	RD%VS 220J
R10	Carbon film 100	RD%PS 101J
R11	Carbon film 8.2k	RD%VS 822J
R12	Carbon film 10k	RD%VS 103J
R13	Carbon film 2.7k	RD%VS 272J
R14		
R15	Carbon film 100	RD%PS 101J
R16	Carbon film 330	RD%PS 331J
R17	Carbon film 330	RD%PS 331J
R18	Carbon film 330	RD%PS 331J
R19	Carbon film 560k	RD%PS 564J
R20	Carbon film 12k	RD%PS 123J

Continued on the next page

Symbol	Description	Part No.
R21	Carbon film 2.2k	RD%PS 222J
R22	Carbon film 360	RD%PS 361J
R23	Carbon film 5.6k	RD%PS 562J
R24	Carbon film 10k	RD%PS 103J
R25	Carbon film 2.2k	RD%PS 222J
R26	Carbon film 2.2k	RD%PS 222J
R27	Carbon film 47k	RD%PS 473J
R28	Carbon film 100k	RD%PS 104J
R29	Carbon film 68k	RD%PS 683J
R30	Carbon film 3.3k	RD%PS 332J
R31	Carbon film 3.3k	RD%PS 332J
R32	Carbon film 18k	RD%PS 183J
R33	Carbon film 18k	RD%PS 183J
R34	Carbon film 1k	RD%VS 102J
R35	Carbon film 1k	RD%VS 102J
R36	Carbon film 4.7k	RD%PS 472J
R37	Carbon film 3.3k	RD%PS 332J
R38	Carbon film 22k	RD%PS 223J
R39	Carbon film 680	RD%PS 681J
R40	Carbon film 47	RD%PS 470J
R41	Carbon film 2.2k	RD%PS 222J
R42	Carbon film 100	RD%PS 101J
R43	Carbon film 2.7k	RD%PS 272J
R44	Carbon film 24k	RD%PS 243J
R45	Carbon film 1.2k	RD%PS 122J
R46		
R47	Carbon film 47k	RD%VS 473J

SEMICONDUCTORS

Symbol	Description	Part No.
Q1	FET 3SK45-B	
Q2	Transistor 2SC535-B or A	
Q3	Transistor 2SC535-B	
Q5	IC HA1201	
Q6	IC HA1137	
Q7	IC HA1142	
Q8	IC HA1138	
D1	Diode 1S2076	
D2	Diode 1S2076	

COILS, TRANSFORMERS AND FILTERS

Symbol	Description	Part No.
T1	FM antenna coil	ATC-021-0
T2	FM RF coil	ATC-015-0
T3	FM RF coil	ATC-016-0
T4	FM oscillator coil	ATC-022-0
T5	FM matching transformer	ATE-008-0
T6	FM IF transformer	T73-035-A
T7	19kHz transformer	T75-023-B
T8	MPX transformer	ATM-011-0
T9	AM RF coil	ATB-014-0
T10	AM oscillator coil	ATB-013-0
T11	38kHz filter	ATM-004-0
T12	38kHz filter	ATM-004-0
F1	FM ceramic filter	ATF-013-B
F2	FM ceramic filter	ATF-013-B
F3	FM ceramic filter	ATF-013-B
F4	AM ceramic filter	ATF-009-0
L1	Choke coil	ATH-007-0
L2	RF choke coil	T24-028-A
L3	RF choke coil	T24-028-A
L4	RF choke coil	T24-028-A
L5	RF choke coil	T24-028-A

11.3 EQUALIZER AMPLIFIER ASSEMBLY (W21-004-B)

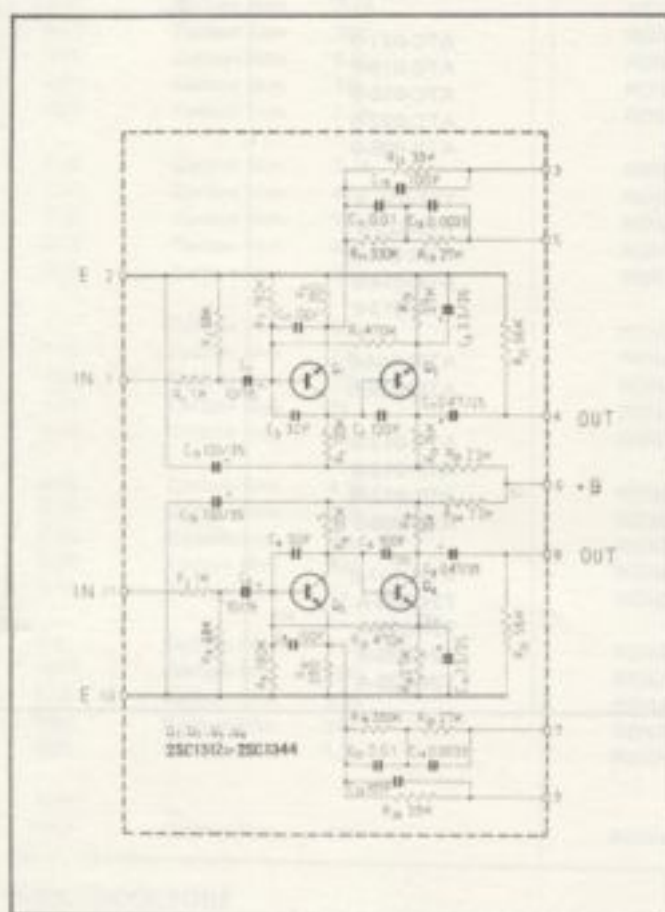

2SC1312



2SC1344

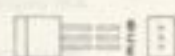

Foil Side

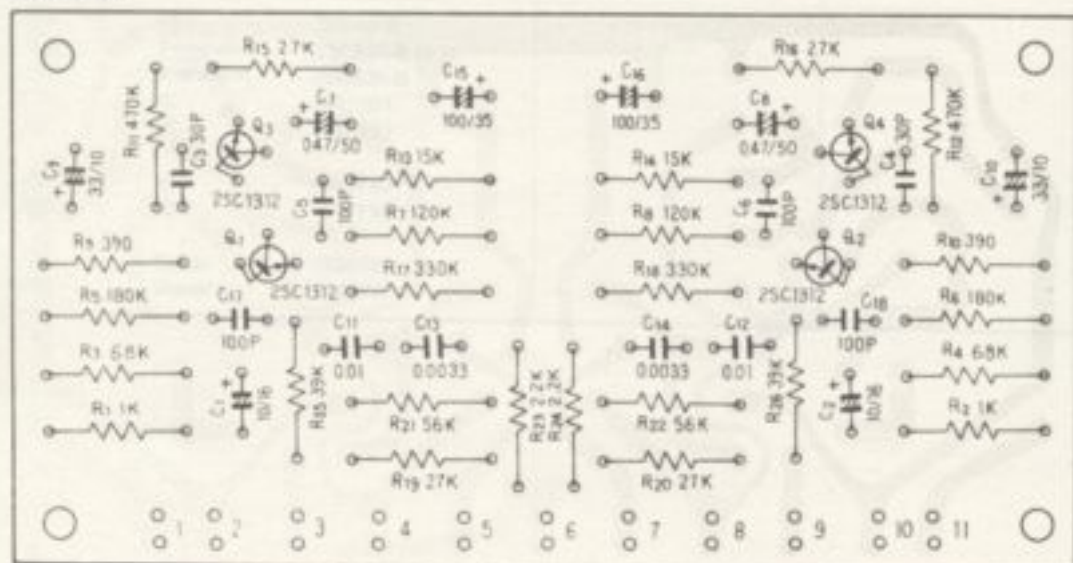

Parts List of Equalizer Amplifier Assembly (W21-004-B)

CAPACITORS

Symbol	Description	Part No.
C1	Electrolytic 10 16V	CEA 100P 16
C2	Electrolytic 10 16V	CEA 100P 16
C3	Ceramic 30p 50V	CCDSL 300K 50
C4	Ceramic 30p 50V	CCDSL 300K 50
C5	Ceramic 100p 50V	CCDSL 101K 50
C6	Ceramic 100p 50V	CCDSL 101K 50
C7	Electrolytic 0.47 25V	CSSA R47M 25
C8	Electrolytic 0.47 25V	CSSA R47M 25
C9	Electrolytic 3.3 25V	CEA 3R3P 25
C10	Electrolytic 3.3 25V	CEA 3R3P 25
C11	Mylar 0.01 50V	CQMA 103M 50
C12	Mylar 0.01 50V	CQMA 103M 50
C13	Mylar 0.0033 50V	CQMA 332M 50
C14	Mylar 0.0033 50V	CQMA 332M 50
C15	Electrolytic 100 35V	CEA 101P 35
C16	Electrolytic 100 35V	CEA 101P 35
C17	Ceramic 100p 50V	CCDSL 101K 50
C18	Ceramic 100p 50V	CCDSL 101K 50
C19	Ceramic 100p 50V	CCDSL 101K 50
C20	Ceramic 100p 50V	CCDSL 101K 50

RESISTORS

Symbol	Description	Part No.
R1	Carbon film 1k	RD%PS 102J
R2	Carbon film 1k	RD%PS 102J
R3	Carbon film 68k	RD%PS 683J
R4	Carbon film 68k	RD%PS 683J
R5	Carbon film 180k	RD%PS 184J
R6	Carbon film 180k	RD%PS 184J
R7	Carbon film 120k	RD%PS 124J
R8	Carbon film 120k	RD%PS 124J
R9	Carbon film 390	RD%PS 391J
R10	Carbon film 390	RD%PS 391J
R11	Carbon film 470k	RD%PS 474J
R12	Carbon film 470k	RD%PS 474J
R13	Carbon film 15k	RD%PS 153J
R14	Carbon film 15k	RD%PS 153J
R15	Carbon film 2.7k	RD%PS 272J
R16	Carbon film 2.7k	RD%PS 272J
R17	Carbon film 330k	RD%PS 334J
R18	Carbon film 330k	RD%PS 334J
R19	Carbon film 27k	RD%PS 273J
R20	Carbon film 27k	RD%PS 273J

Continued on the next page

Symbol	Description	Part No.
R21	Carbon film 56k	RD%PS 563J
R22	Carbon film 56k	RD%PS 563J
R23	Carbon film 2.2k	RD%PS 222J
R24	Carbon film 2.2k	RD%PS 222J
R25	Carbon film 39k	RD%PS 393J
R26	Carbon film 39k	RD%PS 393J

SEMICONDUCTORS

Symbol	Description	Part No.
Q1	Transistor 2SC1312-G or F 2SC1344-E or D	
Q2	Transistor 2SC1312-G or F 2SC1344-E or D	
Q3	Transistor 2SC1312-G or F 2SC1344-E or D	
Q4	Transistor 2SC1312-G or F 2SC1344-E or D	

11.4 CONTROL AMPLIFIER ASSEMBLY (AWG-008-A)

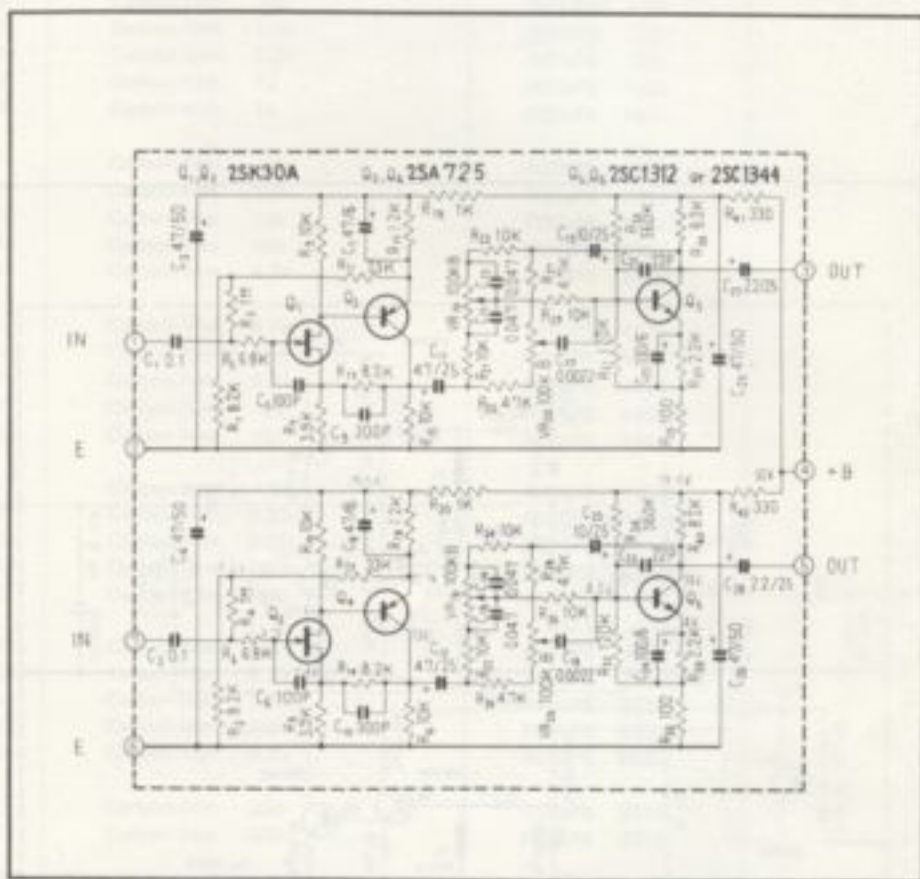

Foil Side

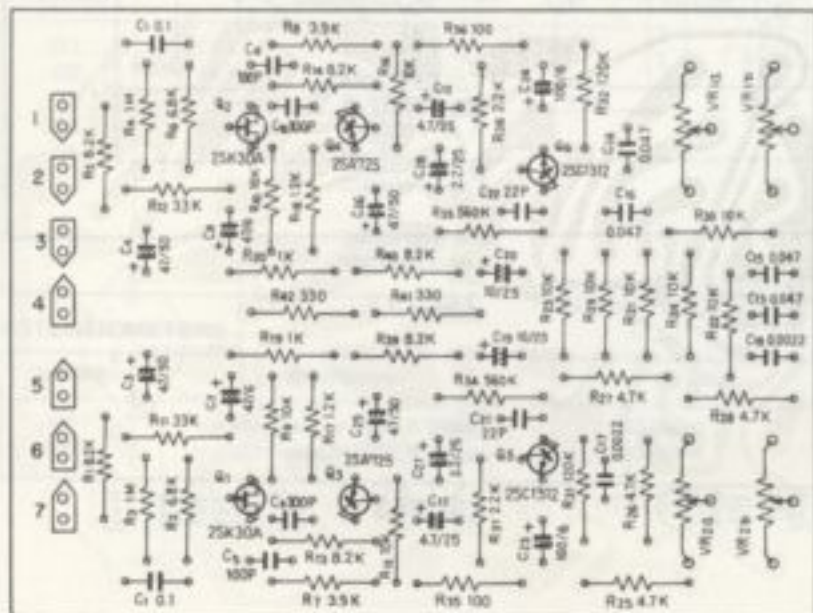

2SK30A

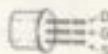

2SC1344



2SA725

2SC1312



Parts List of Control Amplifier Assembly (AWG-008-A)

CAPACITORS

Symbol	Description	Part No.
C1	Mylar 0.1 50V	QOMA 104K 50
C2	Mylar 0.1 50V	QOMA 104K 50
C3	Electrolytic 47 50V	CEA 470P 50
C4	Electrolytic 47 50V	CEA 470P 50
C5	Ceramic 100p 50V	CCDSL 101K 50
C6	Ceramic 100p 50V	CCDSL 101K 50
C7	Electrolytic 47 6V	CEA 470P 6
C8	Electrolytic 47 6V	CEA 470P 6
C9	Ceramic 300p 50V	CKDYB 301K 50
C10	Ceramic 300p 50V	CKDYB 301K 50
C11	Electrolytic 4.7 25V	CEA 4R7P 25
C12	Electrolytic 4.7 25V	CEA 4R7P 25
C13	Mylar 0.047 50V	QOMA 473J 50
C14	Mylar 0.047 50V	QOMA 473J 50
C15	Mylar 0.047 50V	QOMA 473J 50
C16	Mylar 0.047 50V	QOMA 473J 50
C17	Mylar 0.0022 50V	QOMA 222K 50
C18	Mylar 0.0022 50V	QOMA 222K 50
C19	Electrolytic 10 25V	CEA 100P 25
C20	Electrolytic 10 25V	CEA 100P 25
C21	Ceramic 22p 50V	CCDSL 220K 50
C22	Ceramic 22p 50V	CCDSL 220K 50
C23	Electrolytic 100 6V	CEA 101P 6
C24	Electrolytic 100 6V	CEA 101P 6
C25	Electrolytic 47 50V	CEA 470P 50
C26	Electrolytic 47 50V	CEA 470P 50
C27	Electrolytic 2.2 25V	CSSA 2R2X 25
C28	Electrolytic 2.2 25V	CSSA 2R2X 25

RESISTORS

Symbol	Description	Part No.
R1	Carbon film 8.2k	RD%PS 822J
R2	Carbon film 8.2k	RD%PS 822J
R3	Carbon film 1M	RD%PS 105JNL
R4	Carbon film 1M	RD%PS 105JNL
R5	Carbon film 6.8k	RD%PS 682J
R6	Carbon film 6.8k	RD%PS 682J
R7	Carbon film 3.9k	RD%PS 392J
R8	Carbon film 3.9k	RD%PS 392J
R9	Carbon film 10k	RD%PS 103J
R10	Carbon film 10k	RD%PS 103J
R11	Carbon film 33k	RD%PS 333J
R12	Carbon film 33k	RD%PS 333J
R13	Carbon film 8.2k	RD%PS 822J
R14	Carbon film 8.2k	RD%PS 822J
R15	Carbon film 10k	RD%PS 103J

Continued on the next page

Symbol	Description	Part No.
R16	Carbon film 10k	RD%PS 103J
R17	Carbon film 1.2k	RD%PS 122J
R18	Carbon film 1.2k	RD%PS 122J
R19	Carbon film 1k	RD%PS 102J
R20	Carbon film 1k	RD%PS 102J
R21	Carbon film 10k	RD%PS 103J
R22	Carbon film 10k	RD%PS 103J
R23	Carbon film 10k	RD%PS 103J
R24	Carbon film 10k	RD%PS 103J
R25	Carbon film 4.7k	RD%PS 472J
R26	Carbon film 4.7k	RD%PS 472J
R27	Carbon film 4.7k	RD%PS 472J
R28	Carbon film 4.7k	RD%PS 472J
R29	Carbon film 10k	RD%PS 103J
R30	Carbon film 10k	RD%PS 103J
R31	Carbon film 120k	RD%PS 124JNL
R32	Carbon film 120k	RD%PS 124JNL
R33	Carbon film 560k	RD%PS 564JNL
R34	Carbon film 560k	RD%PS 564JNL
R35	Carbon film 100	RD%PS 101J
R36	Carbon film 100	RD%PS 101J
R37	Carbon film 2.2k	RD%PS 222J
R38	Carbon film 2.2k	RD%PS 222J
R39	Carbon film 8.2k	RD%PS 822J
R40	Carbon film 8.2k	RD%PS 822J
R41	Carbon film 330	RD%PS 331J
R42	Carbon film 330	RD%PS 331J

SEMICONDUCTORS

Symbol	Description	Part No.
Q1	FET 2SK30A-Y or RG	
Q2	FET 2SK30A-Y or RG	
Q3	Transistor 2SA725-F or G	
Q4	Transistor 2SA725-F or G	
Q5	Transistor 2SC1312-F or G 2SC1344-D or E	
Q6	Transistor 2SC1312-F or G 2SC1344-D or E	

POTENTIOMETERS

Symbol	Description	Part No.
VR1	Variable resistor 100k-B (Bass)	C82-050-0
VR2	Variable resistor 100k-B (Treble)	C82-050-0

11.5 POWER AMPLIFIER ASSEMBLY (AWH-002-E), (AWH-013-B for NBW model)

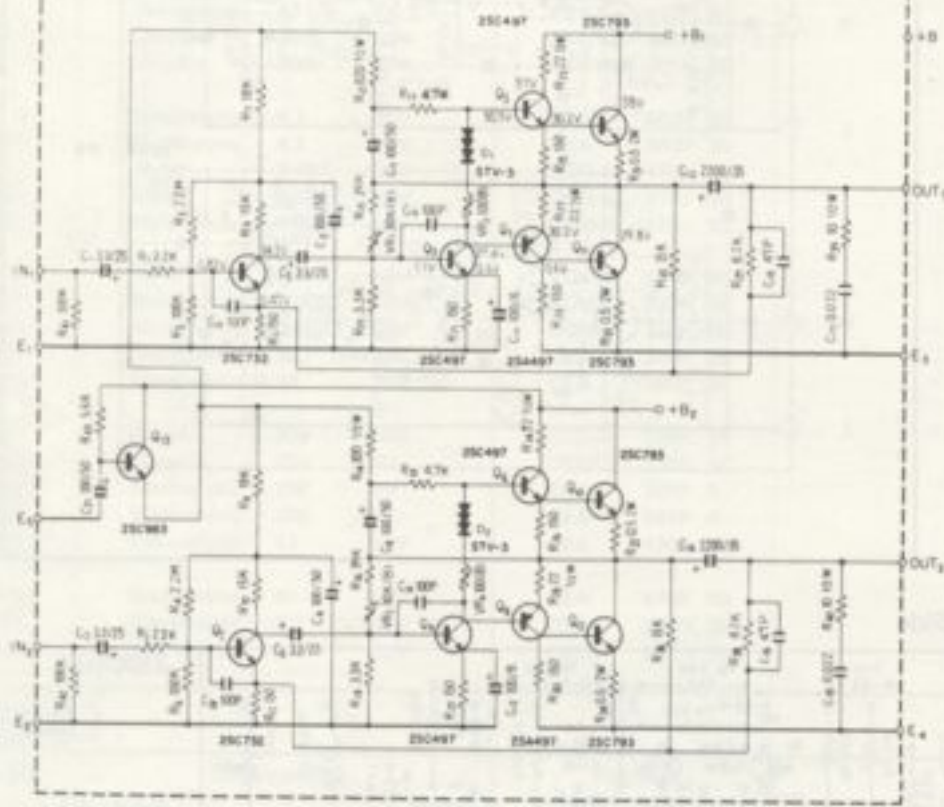

2SA497
2SC497



2SC793

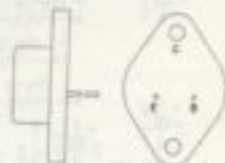

2SC732

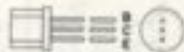

2SC983



Foil Side

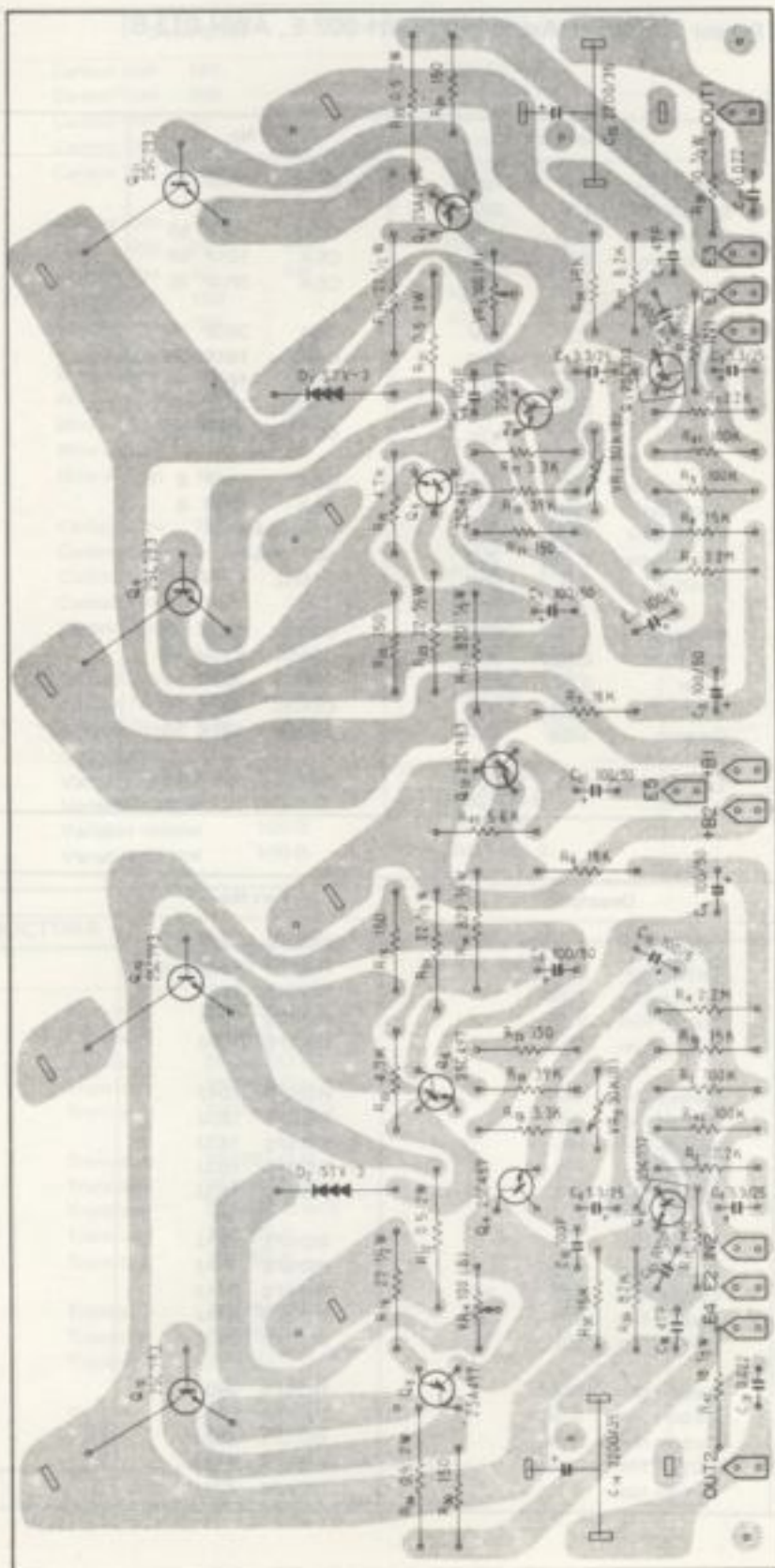

Parts List of Power Amplifier Assembly (AWH-002-E, AWH-013-B)

CAPACITORS

Symbol	Description	Part No.
C1	Electrolytic 3.3 10V	CEA 3R3P 10
C2	Electrolytic 3.3 10V	CEA 3R3P 10
C3	Electrolytic 100 50V	CEA 101P 50
C4	Electrolytic 100 50V	CEA 101P 50
C5	Electrolytic 3.3 25V	CEA 3R3P 25
C6	Electrolytic 3.3 25V	CEA 3R3P 25
C7	Electrolytic 100 50V	CEA 101P 50
C8	Electrolytic 100 50V	CEA 101P 50
C9	Ceramic 100p 50V	CCDSL 101K 50
C10	Ceramic 100p 50V	CCDSL 101K 50
C11	Electrolytic 100 6V	CEA 101P 6
C12	Electrolytic 100 6V	CEA 101P 6
C13	Electrolytic 2,200 35V	ACH-004-A
C14	Electrolytic 2,200 35V	ACH-004-A
C15	Ceramic 47p 50V	CCDSL 470K 50
C16	Ceramic 47p 50V	CCDSL 470K 50
C17	Mylar 0.022 50V	QOMA 223M 50
C18	Mylar 0.022 50V	QOMA 223M 50
C19	Ceramic 100p 50V	CCDSL 101K 50
C20	Ceramic 100p 50V	CCDSL 101K 50
C21	Electrolytic 100 50V	CEA 101P 50

RESISTORS

Symbol	Description	Part No.
R1	Carbon film 2.2k	RD%PS 222J
R2	Carbon film 2.2k	RD%PS 222J
R3	Carbon film 2.2M	RD%PS 225J
R4	Carbon film 2.2M	RD%PS 225J
R5	Carbon film 100k	RD%PS 104J
R6	Carbon film 100k	RD%PS 104J
R7	Carbon film 18k	RD%PS 183J
R8	Carbon film 18k	RD%PS 183J
R9	Carbon film 15k	RD%PS 153J
R10	Carbon film 15k	RD%PS 153J
R11	Carbon film 150	RD%PS 151J
R12	Carbon film 150	RD%PS 151J
R13	Carbon film 820 $\frac{1}{2}W$	RD%PS 821J
R14	Carbon film 820 $\frac{1}{2}W$	RD%PS 821J
R15	Carbon film 39k	RD%PS 393J
R16	Carbon film 39k	RD%PS 393J
R17	Carbon film 3.3k	RD%PS 332J
R18	Carbon film 3.3k	RD%PS 332J
R19	Carbon film 4.7k	RD%PS 472J
R20	Carbon film 4.7k	RD%PS 472J

Symbol	Description	Part No.
R21	Carbon film 150	RD%PS 151J
R22	Carbon film 150	RD%PS 151J
R23	Carbon film 22 1/2W	RD%PS 220J
R24	Carbon film 22 1/2W	RD%PS 220J
R25	Carbon film 150	RD%PS 151J
R26	Carbon film 150	RD%PS 151J
R27	Carbon film 22 1/2W	RD%PS 220J
R28	Carbon film 22 1/2W	RD%PS 220J
R29	Carbon film 150	RD%PS 151J
R30	Carbon film 150	RD%PS 151J
R31	Wire wound 0.5 2W	RT2P 0R5K
R32	Wire wound 0.5 2W	RT2P 0R5K
R33	Wire wound 0.5 2W	RT2P 0R5K
R34	Wire wound 0.5 2W	RT2P 0R5K
R35	Wire wound 15k	RD%PS 153J
R36	Carbon film 15k	RD%PS 153J
R37	Carbon film 8.2k	RD%PS 822J
R38	Carbon film 8.2k	RD%PS 822J
R39	Carbon film 10 1/2W	RD%PS 100J
R40	Carbon film 10 1/2W	RD%PS 100J
R41	Carbon film 100k	RD%PS 104J
R42	Carbon film 100k	RD%PS 104J
R43	Carbon film 5.6k	RD%PS 562J
VR1	Variable resistor 30k-B	C92-024-B
VR2	Variable resistor 30k-B	C92-024-B
VR3	Variable resistor 100-B	ACP-004-0
VR4	Variable resistor 100-B	ACP-004-0

SEMICONDUCTORS

Symbol	Description	Part No.
Q1	Transistor 2SC732	
Q2	Transistor 2SC732	
Q3	Transistor 2SC497-O or Y	
Q4	Transistor 2SC497-O or Y	
Q5	Transistor 2SC497-O or Y	
Q6	Transistor 2SC497-O or Y	
Q7	Transistor 2SA497-O or Y	
Q8	Transistor 2SA497-O or Y	
Q9	Transistor 2SC793-Y	
Q10	Transistor 2SC793-Y	
Q11	Transistor 2SC793-Y	
Q12	Transistor 2SC793-Y	
Q13	Transistor 2SC983-O or Y	
D1	Varistor STV-3	
D2	Varistor STV-3	

11.6 POWER SUPPLY CIRCUIT ASSEMBLY (AWR-029-A)

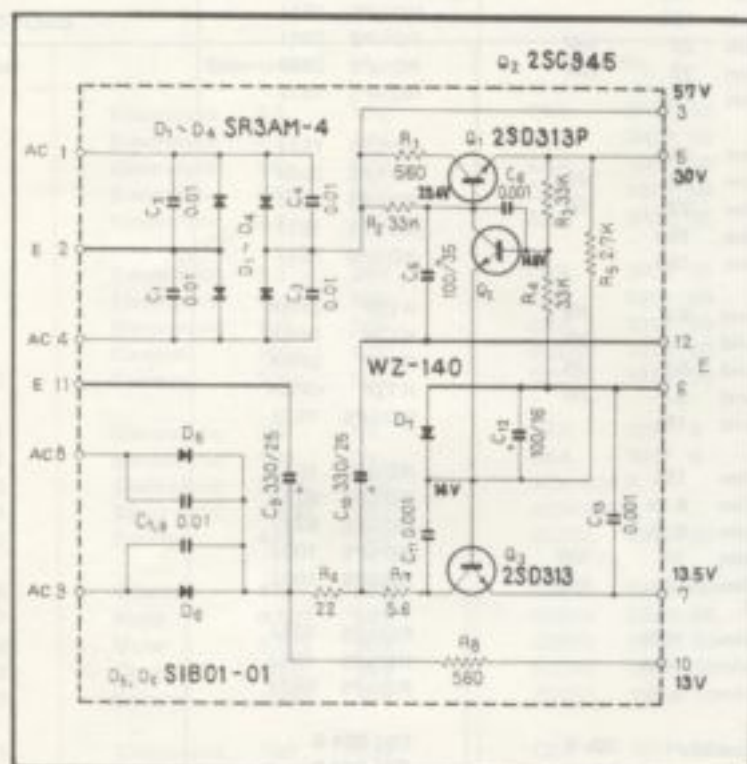

2SC945



2SD313

2SD313P



Foil Side

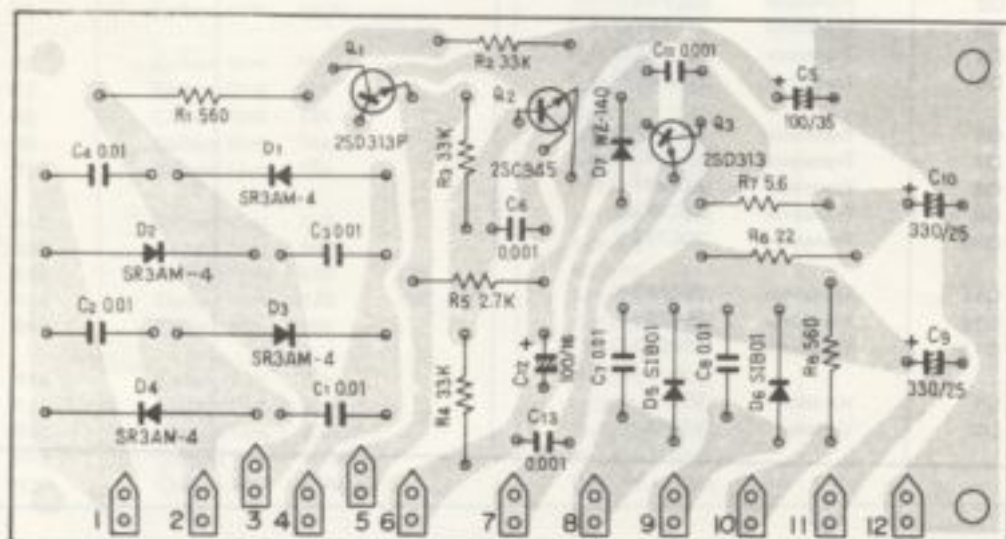

Parts List of Power Supply Circuit Assembly (AWR-029-A)

CAPACITORS

Symbol	Description			Part No.
C1	Ceramic	0.01	DC 1.4kV	C43-003-0
C2	Ceramic	0.01	DC 1.4kV	C43-003-0
C3	Ceramic	0.01	DC 1.4kV	C43-003-0
C4	Ceramic	0.01	DC 1.4kV	C43-003-0
C5	Electrolytic	100	35V	CEA 101P 35
C6	Mylar	0.001	50V	QOMA 102K 50
C7	Ceramic	0.01	DC 1.4kV	C43-003-0
C8	Ceramic	0.01	DC 1.4kV	C43-003-0
C9	Electrolytic	330	25V	CEA 331P 25
C10	Electrolytic	330	25V	CEA 331P 25
C11	Mylar	0.001	50V	QOMA 102K 50
C12	Electrolytic	100	16V	CEA 101P 16
C13	Mylar	0.001	50V	QOMA 102K 50

RESISTORS

Symbol	Description			Part No.
R1	Metal oxide	560	1W	RS1P 561K
R2	Carbon film	33k		RD%PS 333J
R3	Carbon film	33k		RD%PS 333J
R4	Carbon film	33k		RD%PS 333J
R5	Carbon film	2.7k		RD%PS 272J
R6	Carbon film	22	1/2W	RD%PS 220J
R7	Carbon film	5.6		RD%PS 5R6J
R8	Metal oxide	560	1W	RS1P 561K

SEMICONDUCTORS

Symbol	Description			Part No.
Q1	Transistor	2SD313P-E or D		
Q2	Transistor	2SC945-Q or R		
Q3	Transistor	2SD313-E or D		
D1	Diode	SR3AM-4		
D2	Diode	SR3AM-4		
D3	Diode	SR3AM-4		
D4	Diode	SR3AM-4		
D5	Diode	SI801-01		
D6	Diode	SI801-01		
D7	Zener diode	WZ-140		

11.7 SWITCH CIRCUIT ASSEMBLY (AWS-013-A)

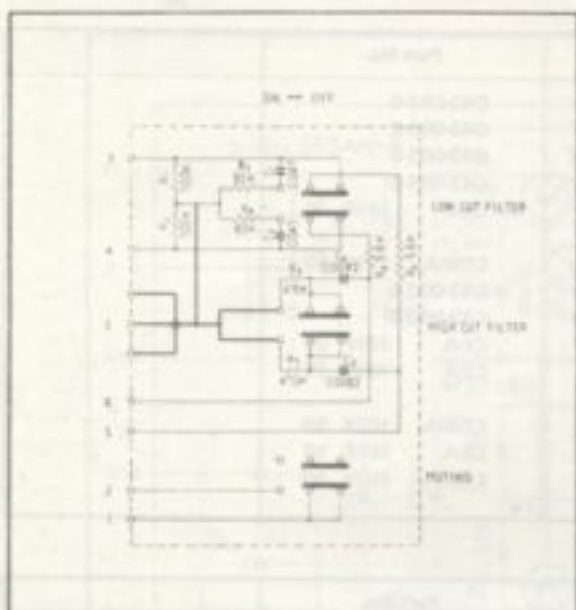

Foil Side

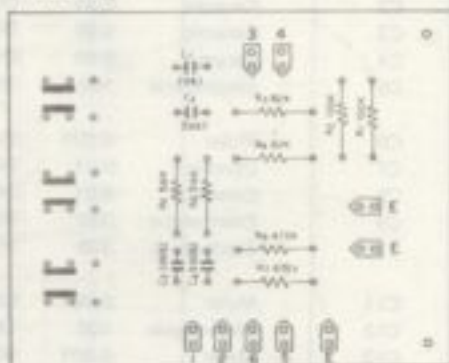

CAPACITORS

Symbol	Description	Part No.
C1	Mylar 0.047 50V	COMA 473K 50
C2	Mylar 0.047 50V	COMA 473K 50
C3	Mylar 0.0082 50V	COMA 822K 50
C4	Mylar 0.0082 50V	COMA 822K 50

RESISTORS

Symbol	Description	Part No.
R1	Carbon film 100k	PD%PS 104J
R2	Carbon film 100k	RD%PS 104J
R3	Carbon film 82k	RD%PS 823J
R4	Carbon film 82k	RD%PS 823J
R5	Carbon film 5.6k	RD%PS 562J
R6	Carbon film 5.6k	RD%PS 562J
R7	Carbon film 470k	RD%PS 474J
R8	Carbon film 470k	RD%PS 474J

SWITCH

Symbol	Description	Part No.
	Push switch	S31-035-0

11.8 SWITCH CIRCUIT ASSEMBLY (AWS-014-O)

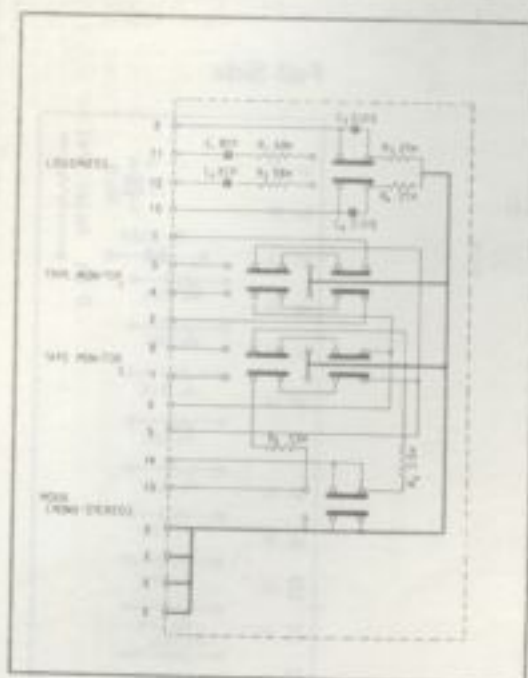

Foil Side

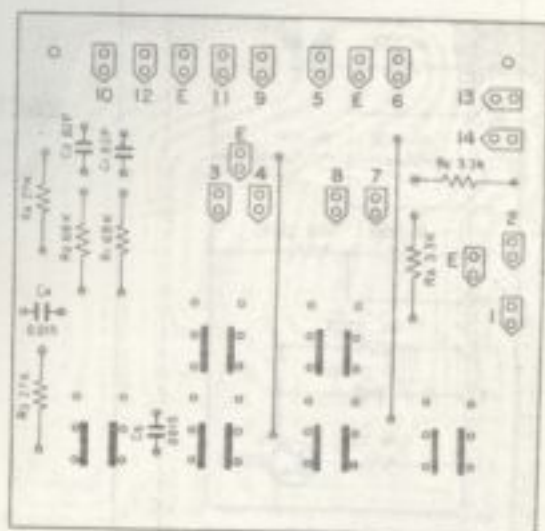

CAPACITORS

Symbol	Description	Part No.
C1	Ceramic 82p 50V	CCDSL 820K 50
C2	Ceramic 82p 50V	CCDSL 820K 50
C3	Mylar 0.015 50V	CQMA 153K 50
C4	Mylar 0.015 50V	CQMA 153K 50

RESISTORS

Symbol	Description	Part No.
R1	Carbon film 68k	RD%PS 683J
R2	Carbon film 68k	RD%PS 683J
R3	Carbon film 27k	RD%PS 273J
R4	Carbon film 27k	RD%PS 273J
R5	Carbon film 3.3k	RD%PS 332J
R6	Carbon film 3.3k	RD%PS 332J

SWITCH

Symbol	Description	Part No.
	Push switch	ASG-012-0

11.9 CR & METER DRIVE ASSEMBLY (AWM-050-0)

Foil Side

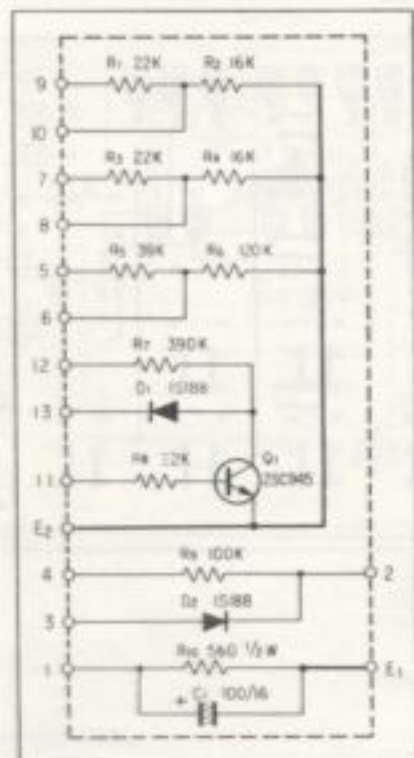

2SC945

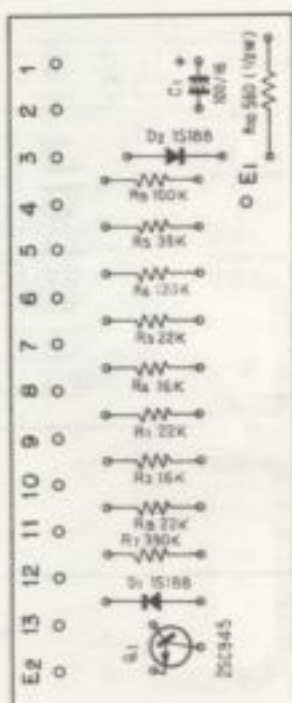

CAPACITORS, RESISTORS AND SEMICONDUCTORS

Symbol	Description	Part No.
C1	Electrolytic 100 16V	CEA 101P 16
R1	Carbon film 22k	RD%PM 223J
R2	Carbon film 16k	RD%PM 163J
R3	Carbon film 22k	RD%PM 223J
R4	Carbon film 16k	RD%PM 163J
R5	Carbon film 39k	RD%PM 393J
R6	Carbon film 120k	RD%PM 124J
R7	Carbon film 390k	RD%PM 394J
R8	Carbon film 22k	RD%PM 223J
R9	Carbon film 100k	RD%PM 104J
R10	Carbon film 560 1/2W	RD%PS 561J
Q1	Transistor 2SC945-Q or R	
D1	Diode 1S188 FM-1	
D2	Diode 1S188 FM-1	

17. P.C. BOARD PATTERN AND PARTS LIST

PIONEER ELECTRONIC CORPORATION

4-1, Meguro 1-Chome, Meguro-ku, Tokyo 153, Japan

U.S. PIONEER ELECTRONICS CORPORATION

75 Oxford Drive, Moonachie, New Jersey 07074, U.S.A.

PIONEER ELECTRONIC (EUROPE) N.V.

Luithagen-Haven 9, 2030 Antwerp, Belgium

PIONEER ELECTRONICS AUSTRALIA PTY. LTD.

178-184 Boundary Road, Braeside, Victoria 3185, Australia

© MAY 1976

Printed in Japan